

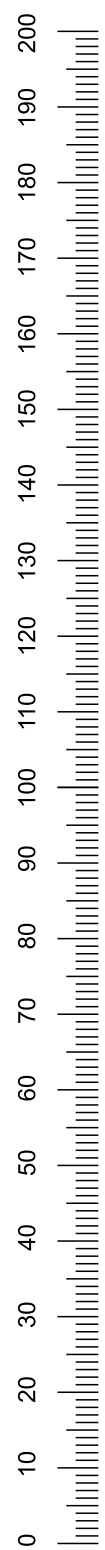

Nr	Ausmaß		St	Colli
1	1950	544	15	1
2	1877	485	15	1
3	1950	573	15	1
4	1670	525	15	2
5	827,5	480	15	2
6	1670	541	15	2
7	1670	42	15	2
8	1670	42	15	2
9	1896	844,5	2	2

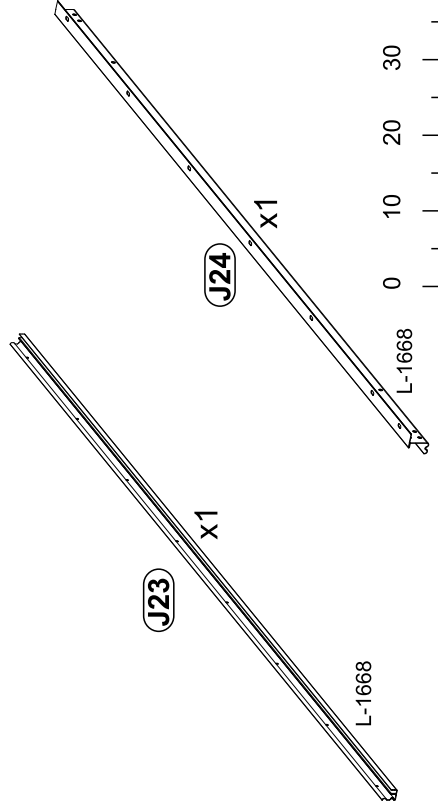

- 1**  x2
-  x16
-  x4

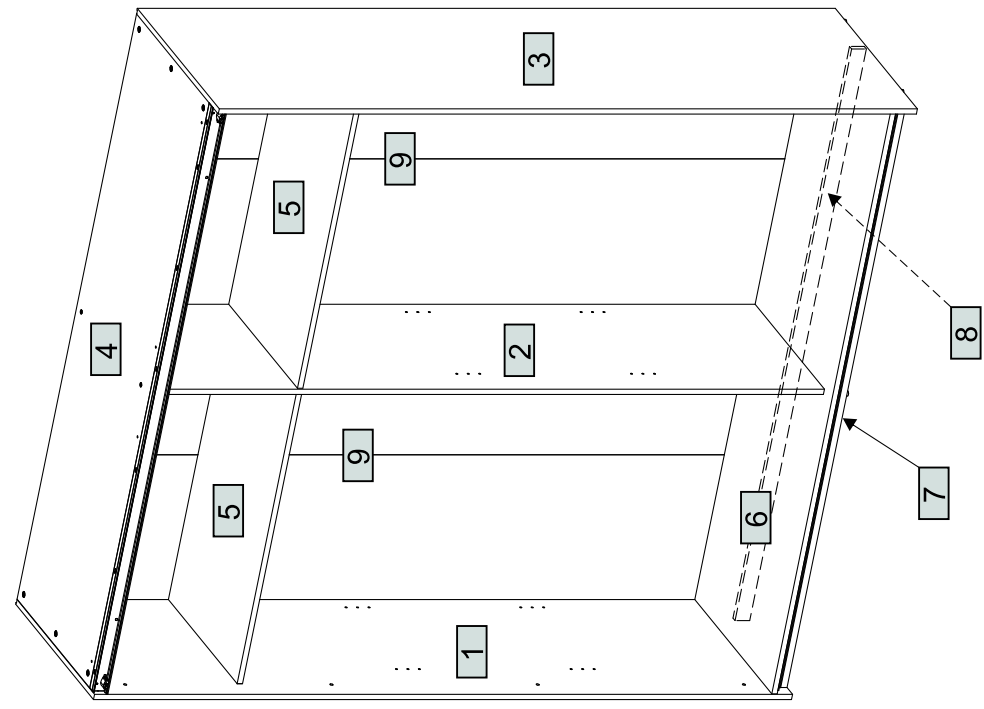
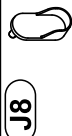
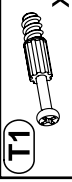

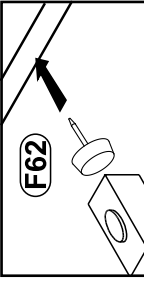
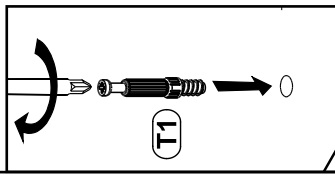
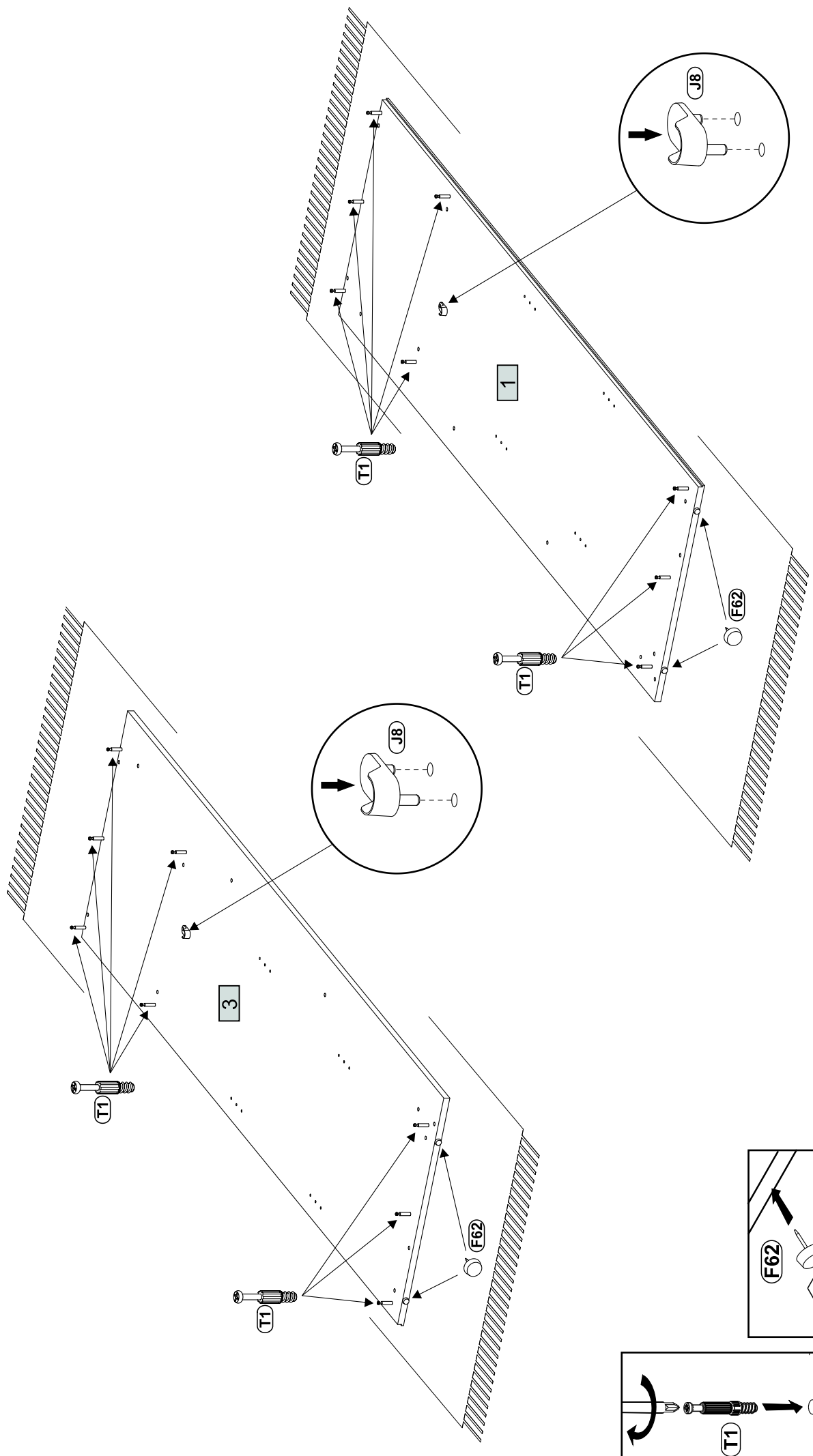
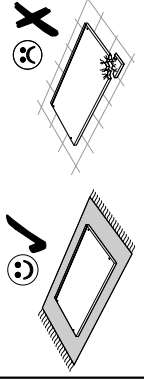
MERLIN KORPUS

58-576_-2

4/10

2

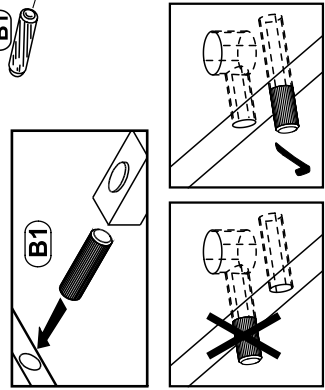
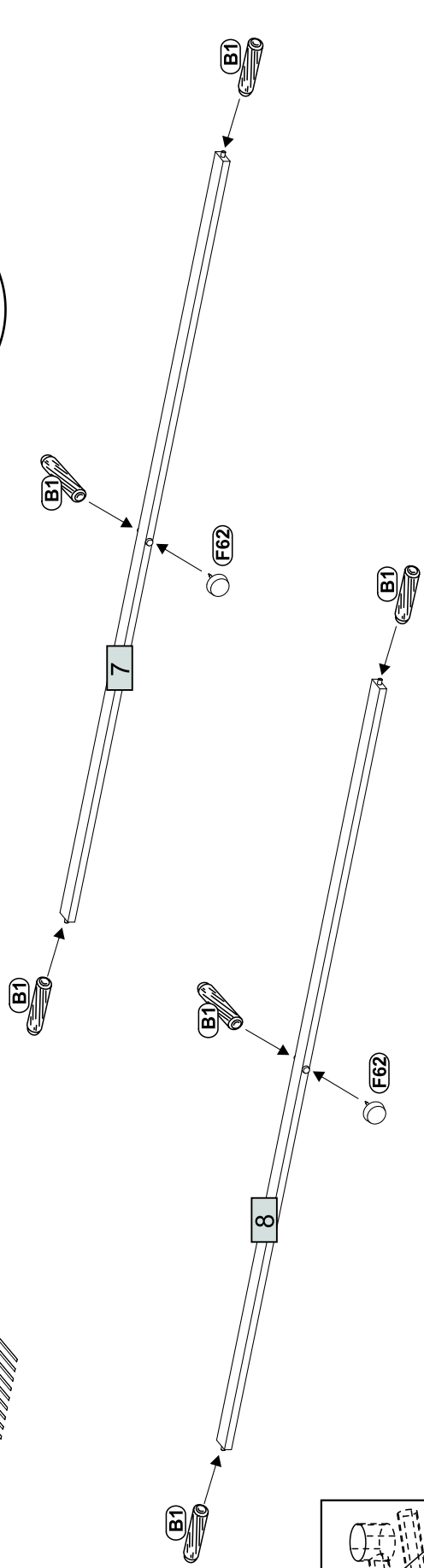
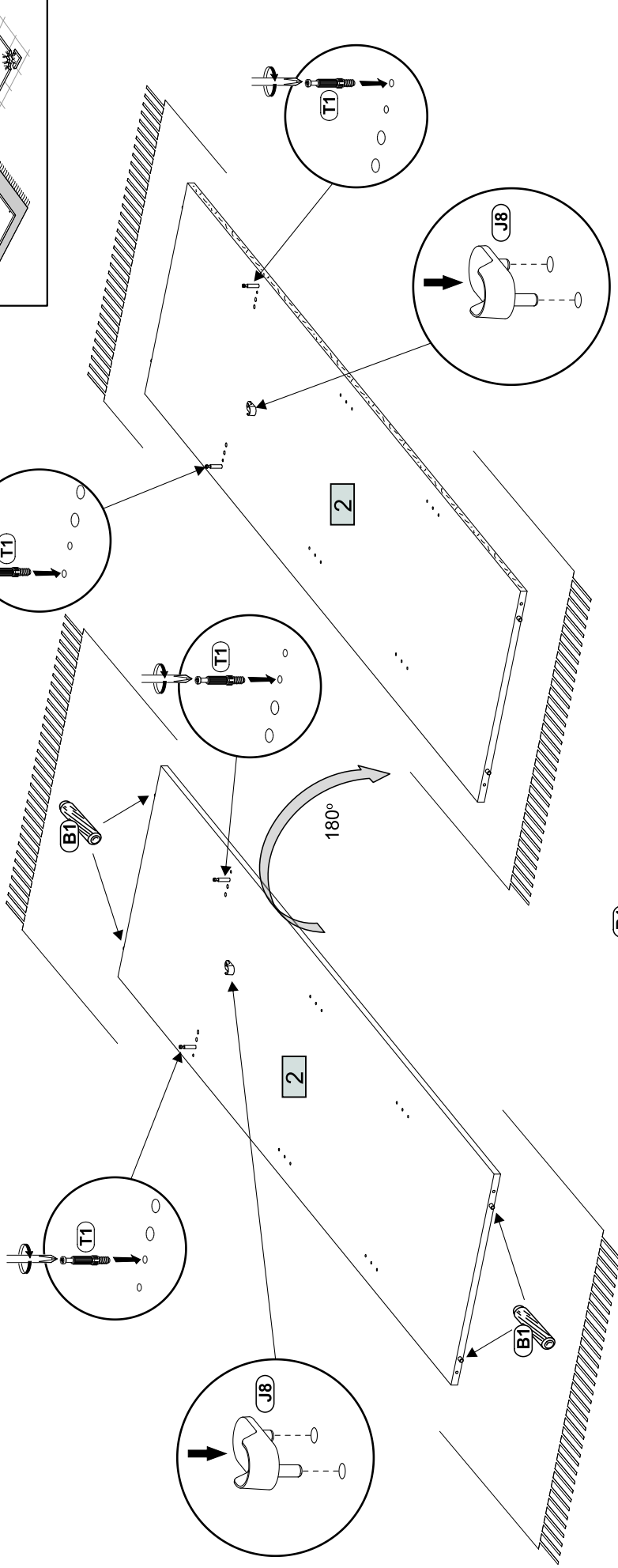
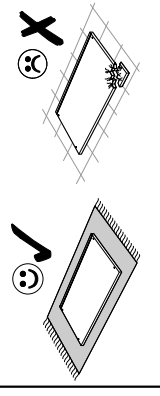
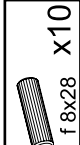
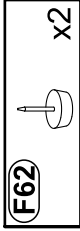
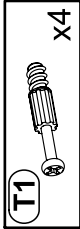
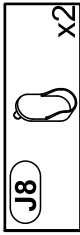

3

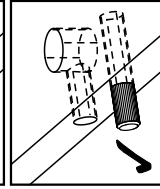
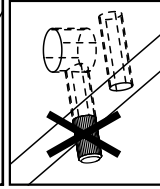
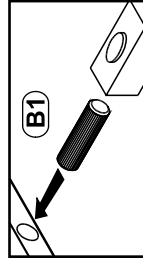
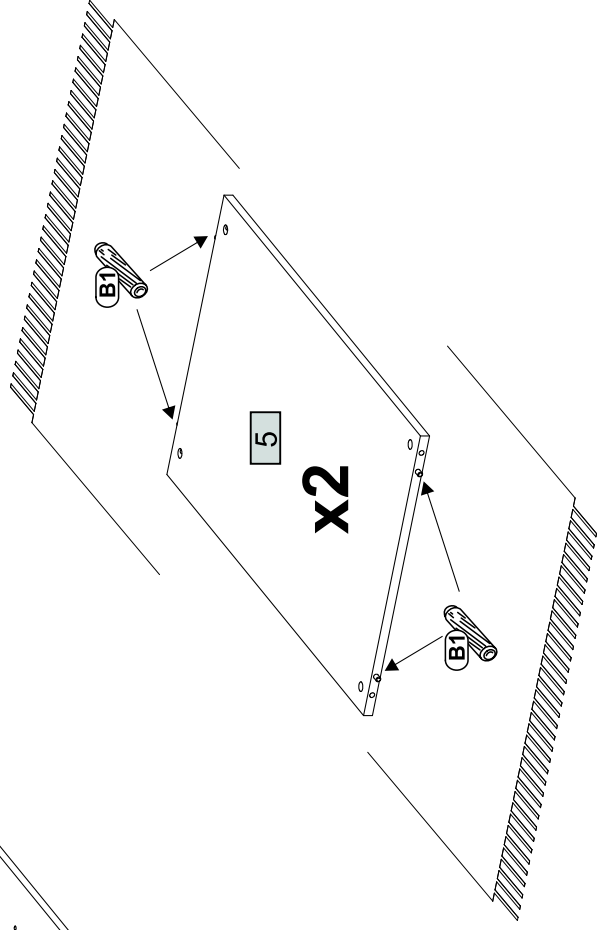
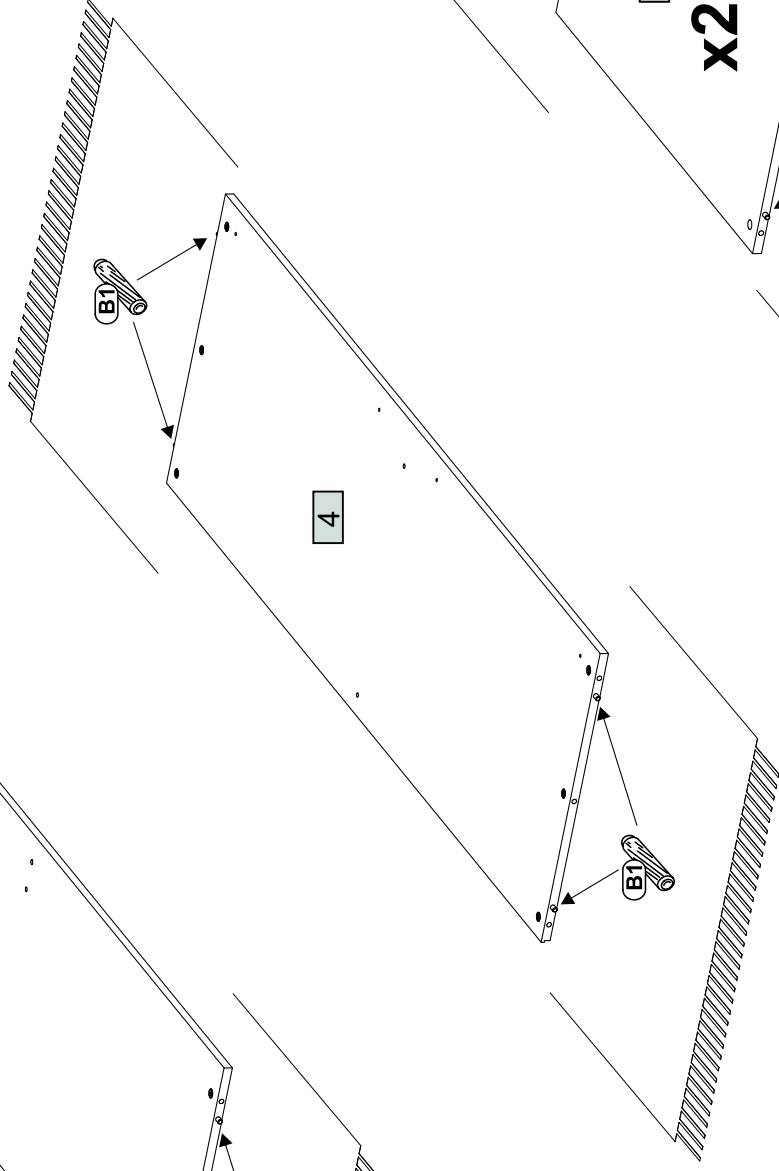
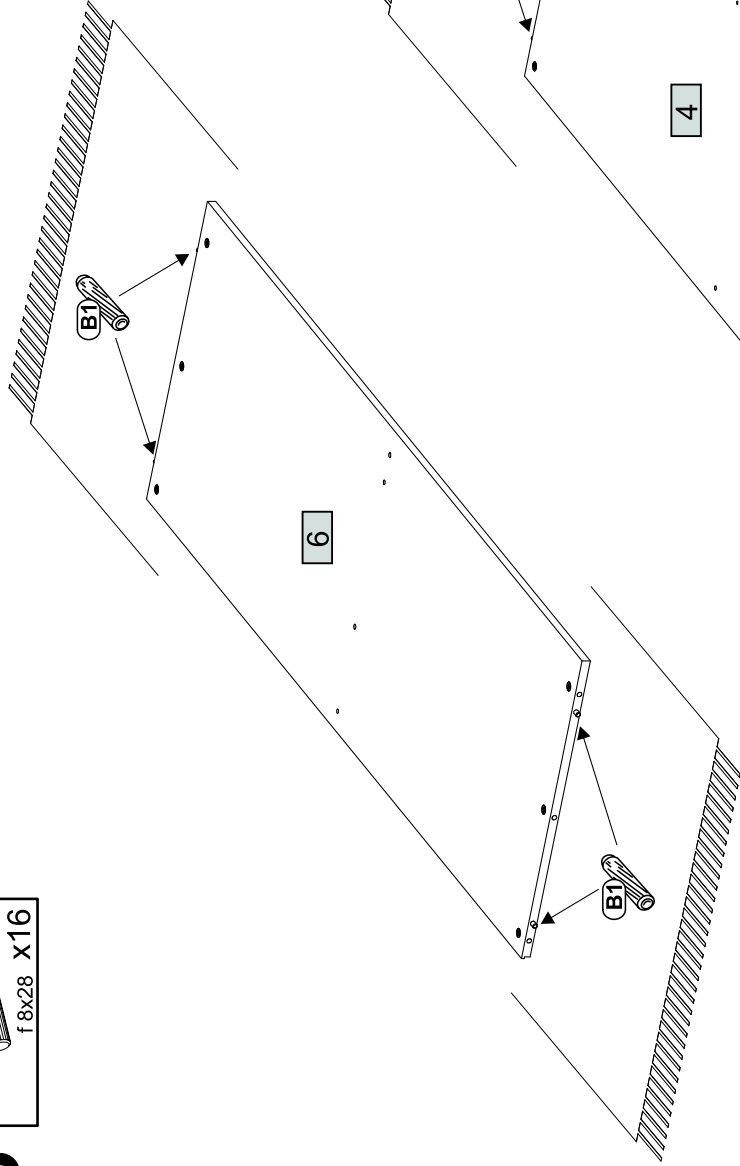
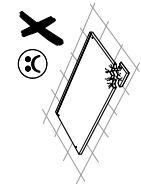
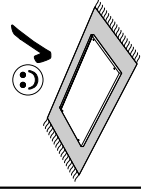

4

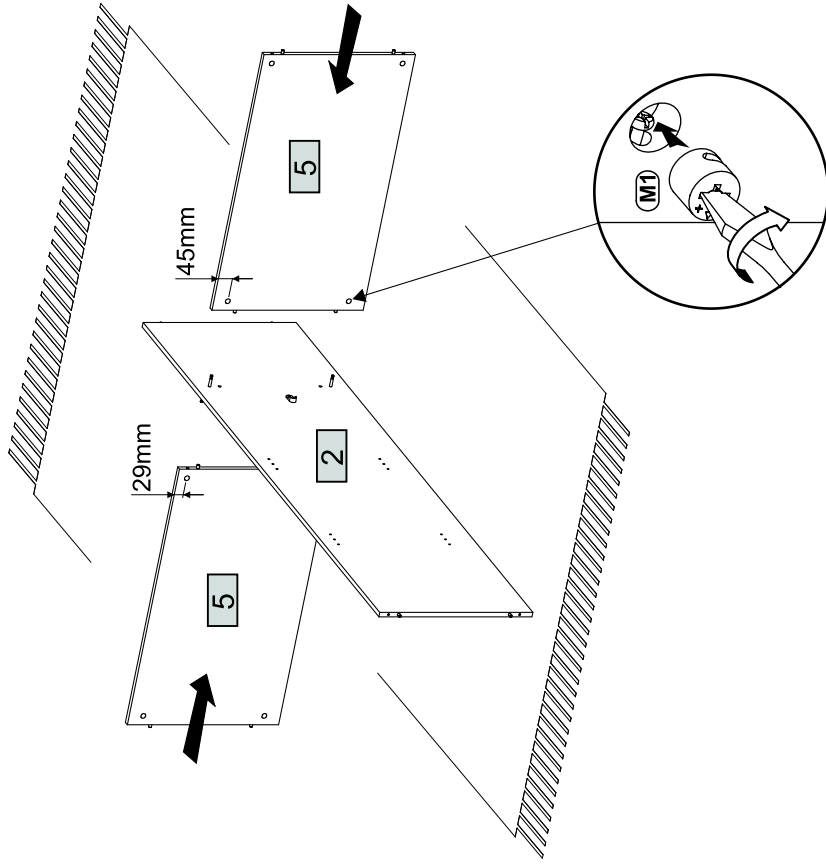
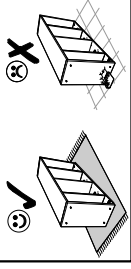

5

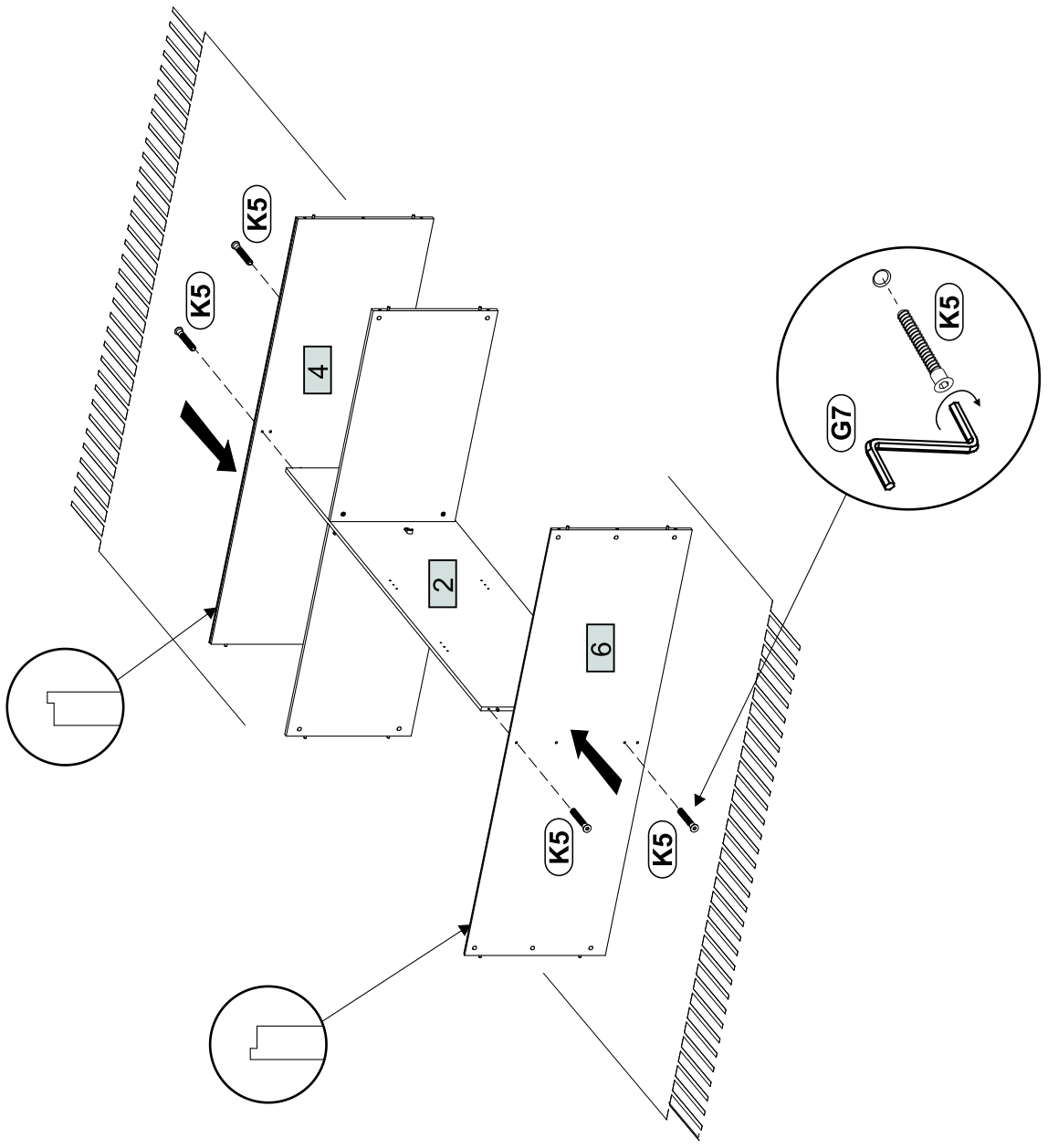
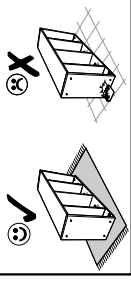
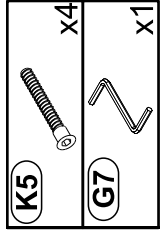

MERLIN KORPUS

58-576_-2

7/10

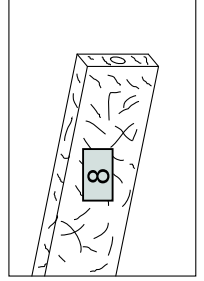
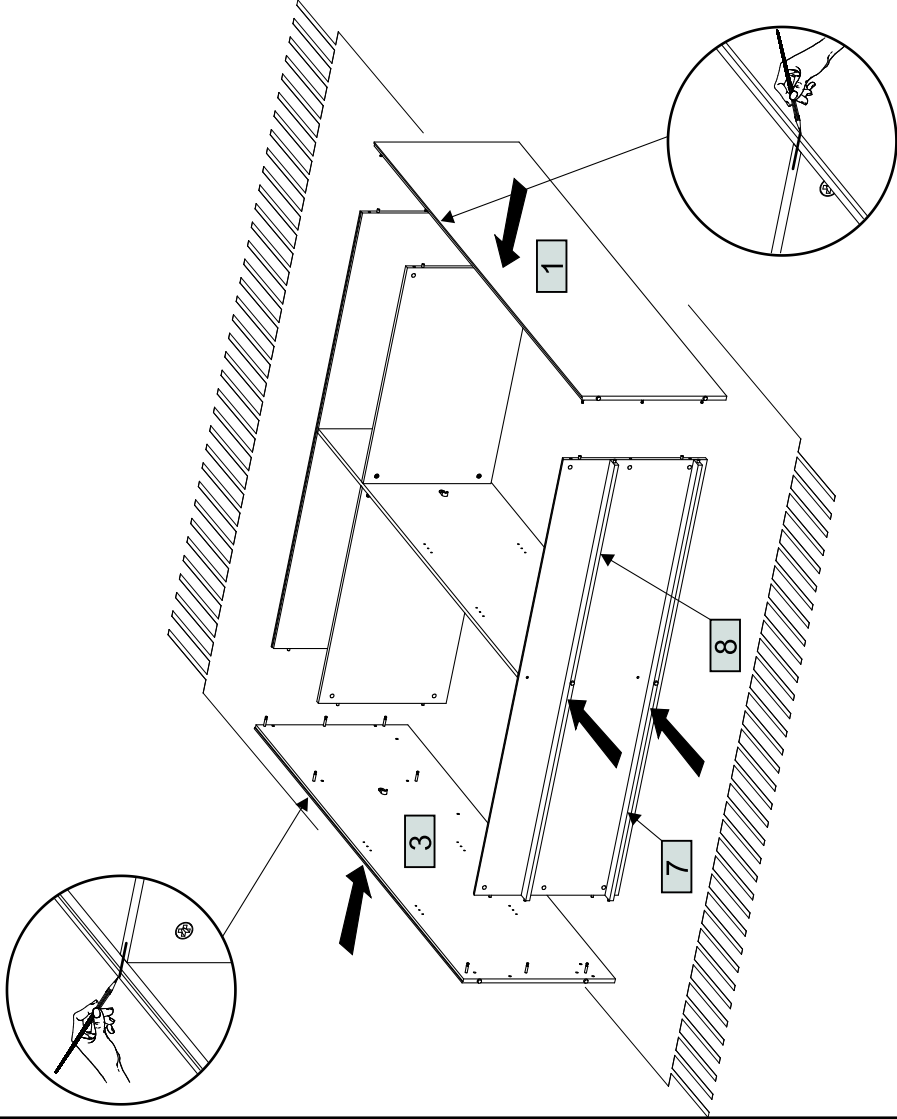
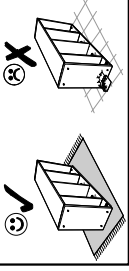
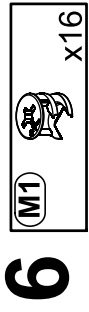

7

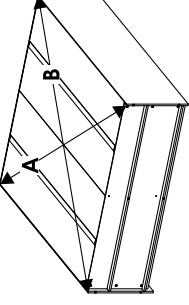
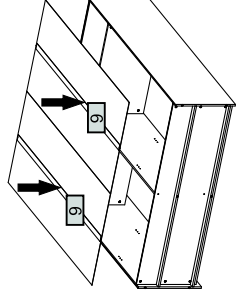
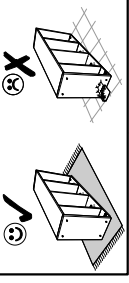

A=B

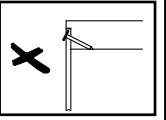
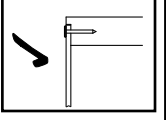
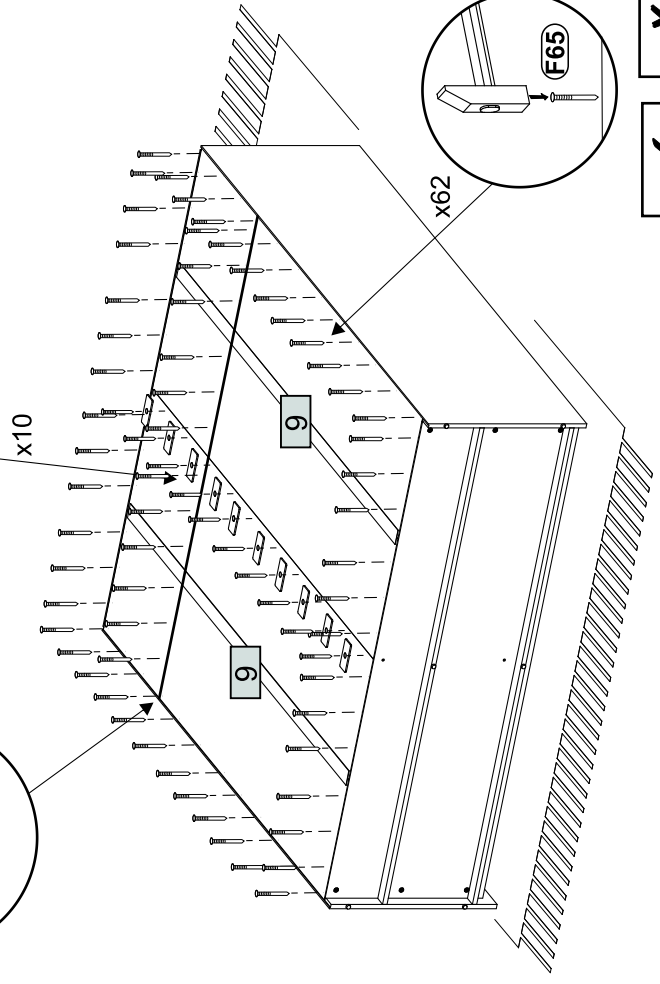
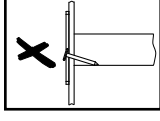
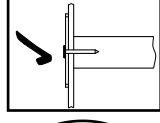
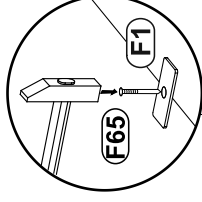
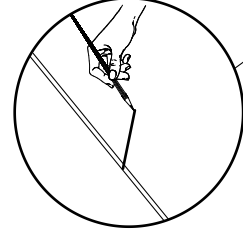
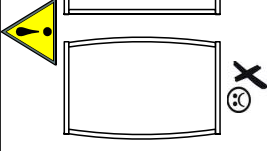

8

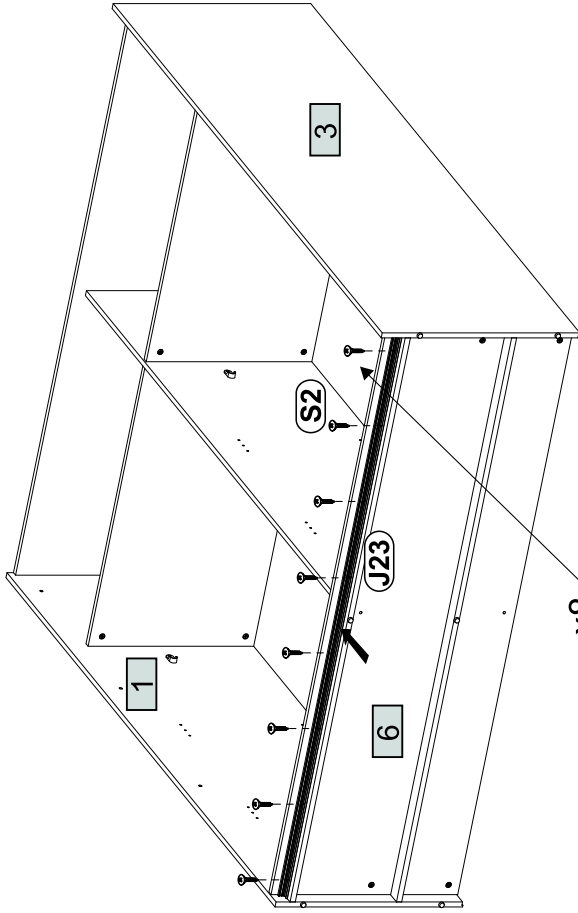
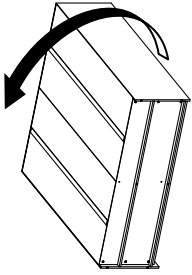
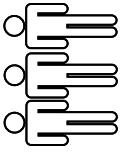
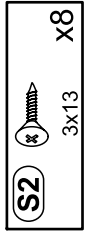
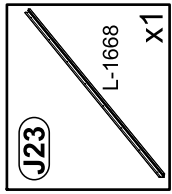

x8

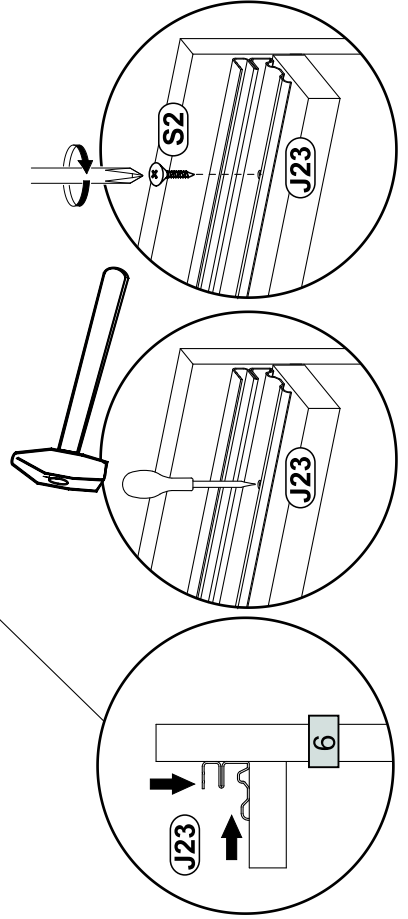

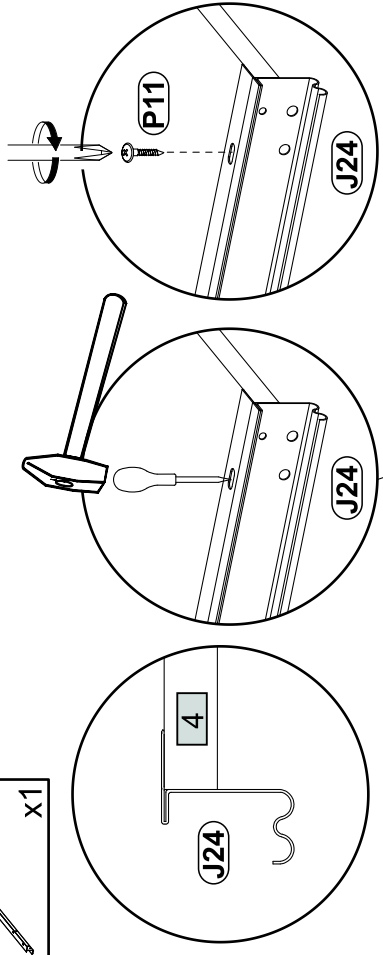
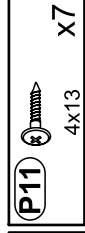
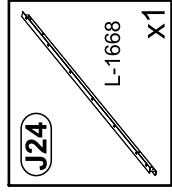

9

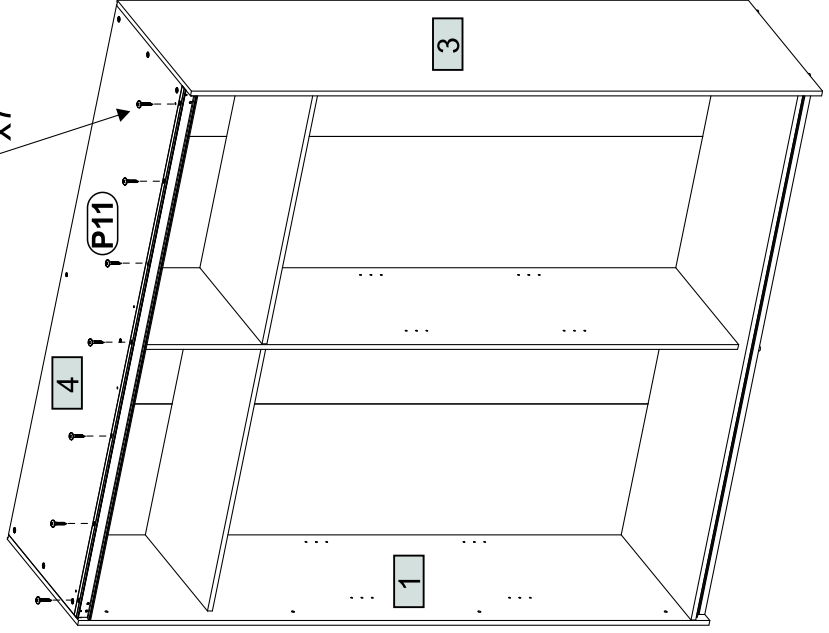

x7



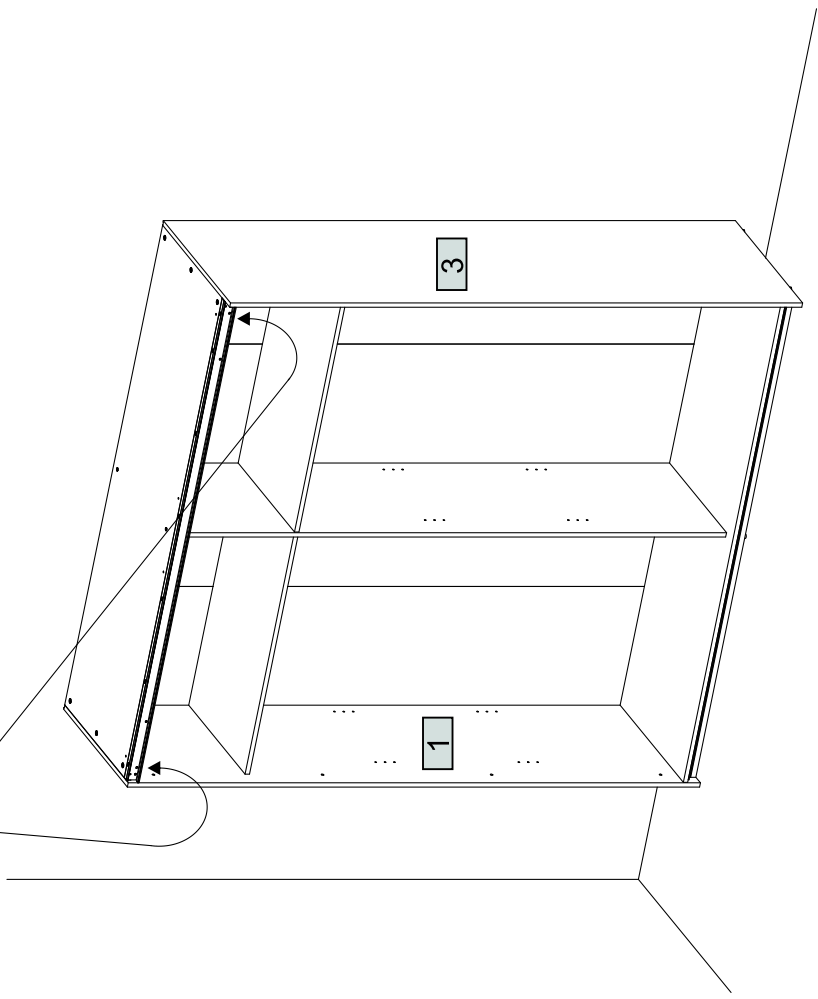
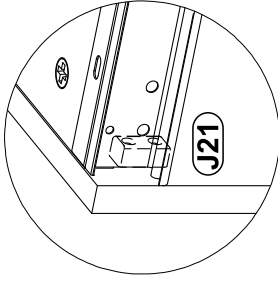
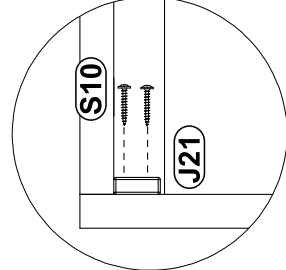
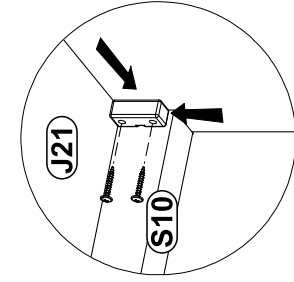

10  x2

 x4
3,5x25



11

 x2
 x2

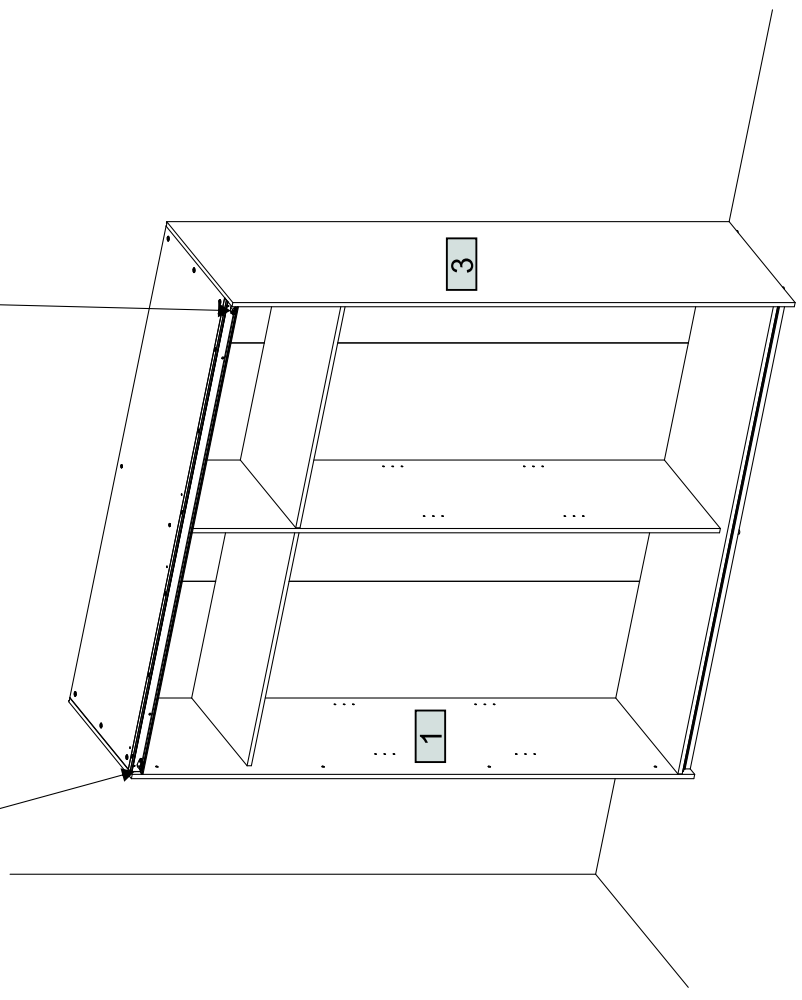
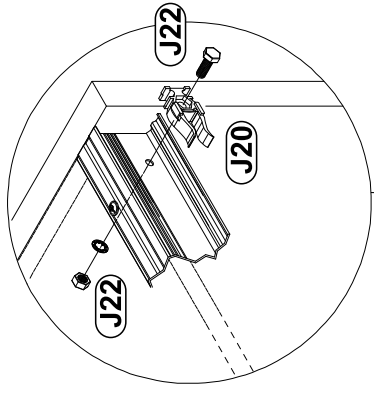
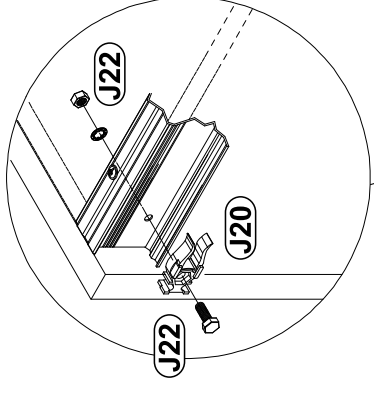

12

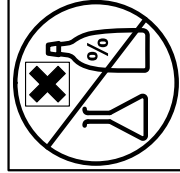
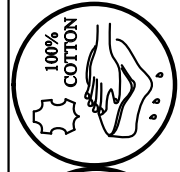
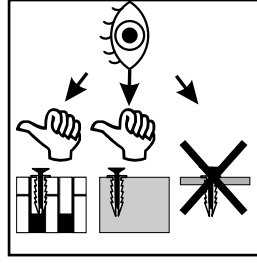
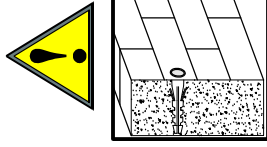
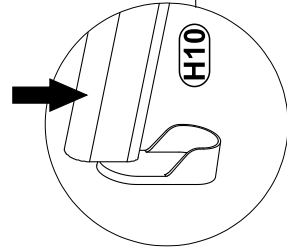
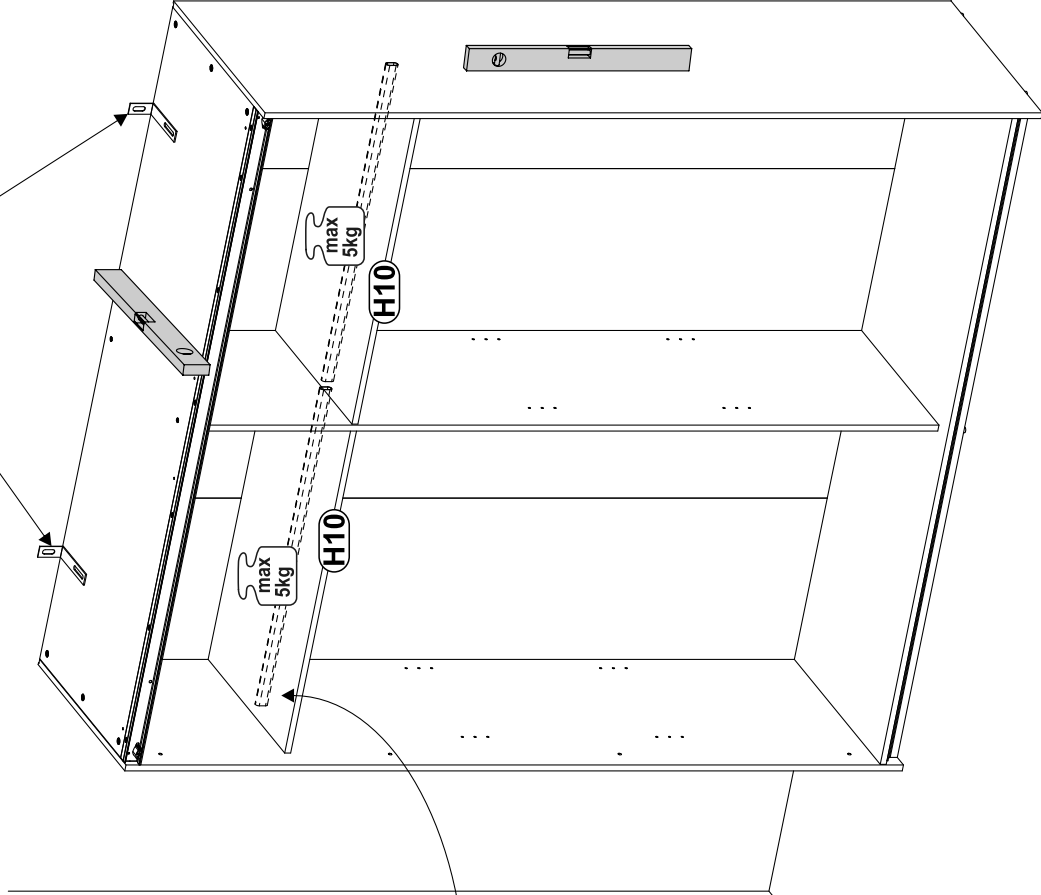
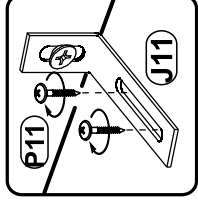
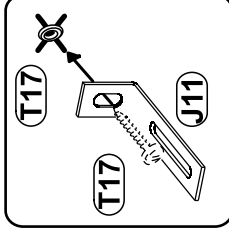
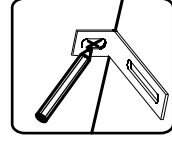
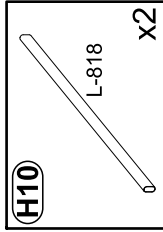
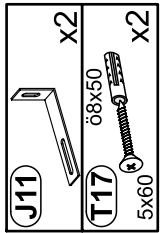

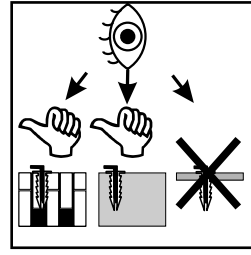
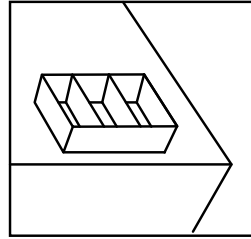
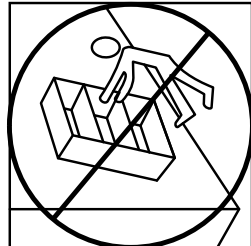
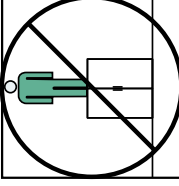
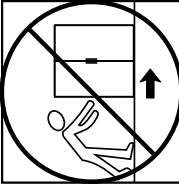
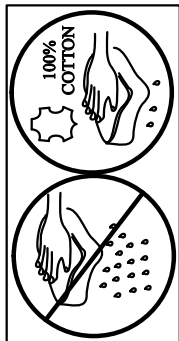
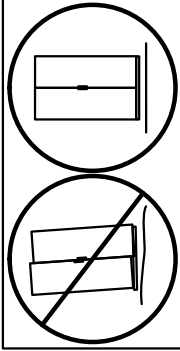
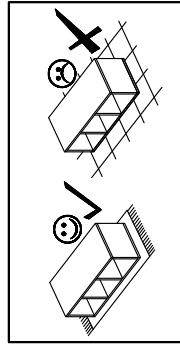
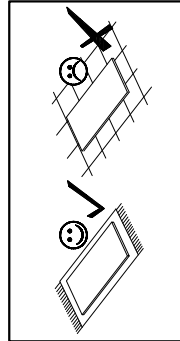
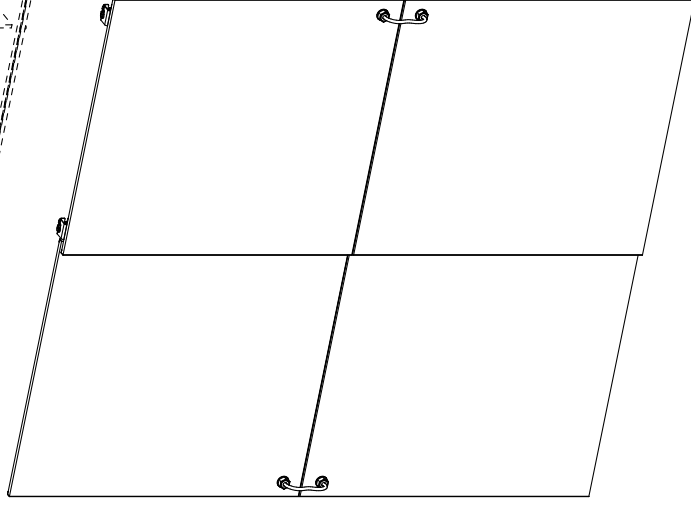
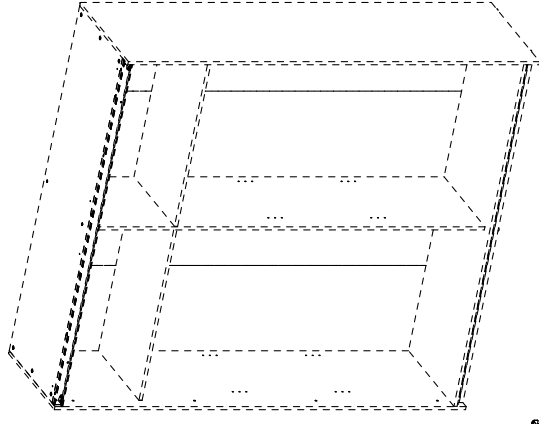
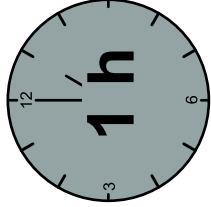
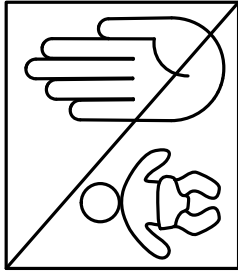
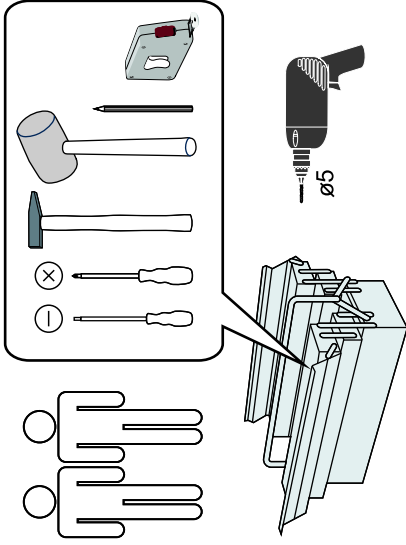
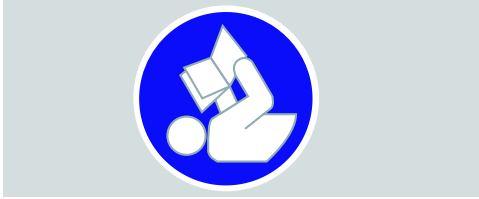

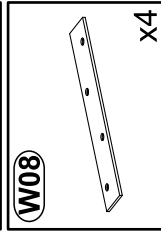
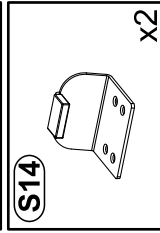
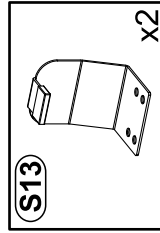
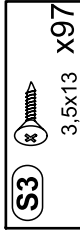
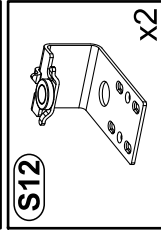
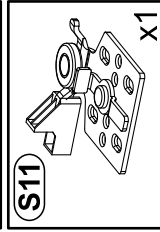
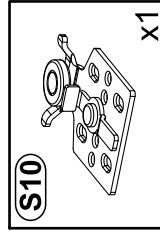

Nr	Ausmaß	St	Colli
10	865 962,5 15	1	3
11	865 962,5 15	1	3
12	865 962,5 15	1	3
13	865 962,5 15	1	3

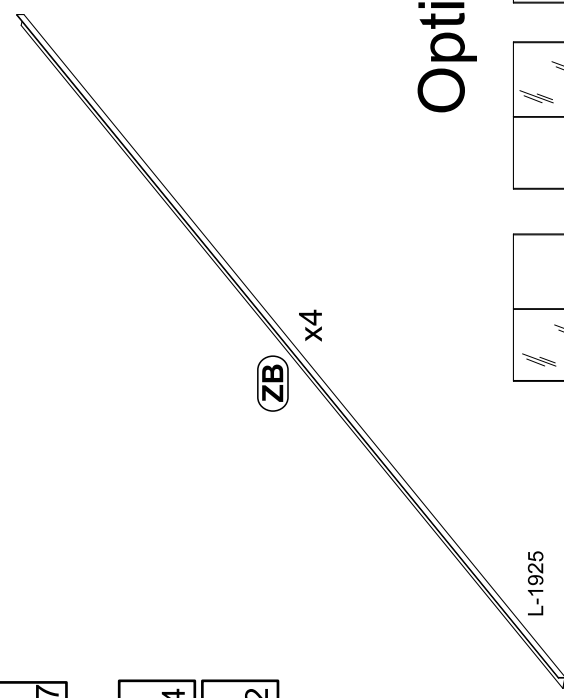
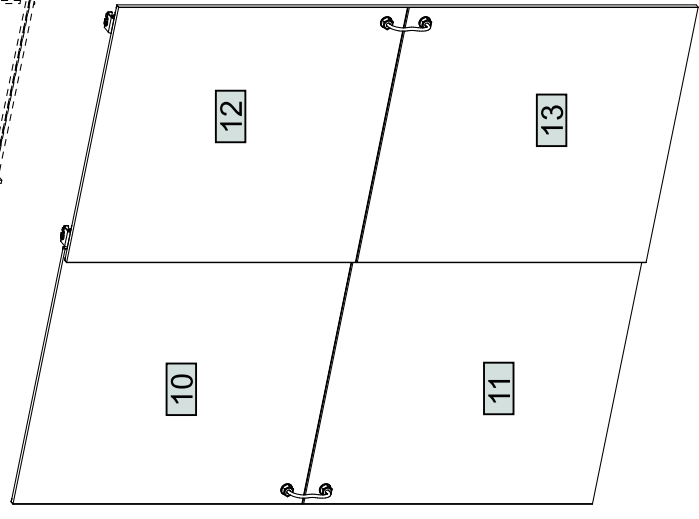
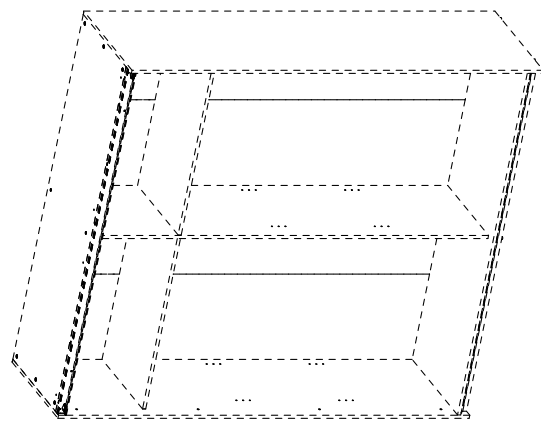

Option

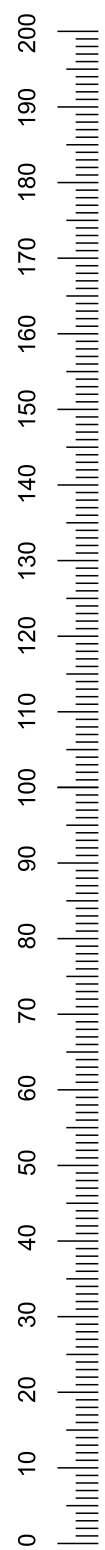
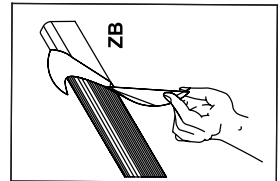
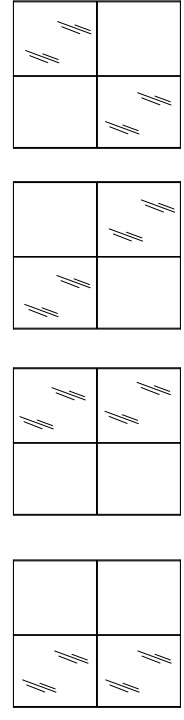

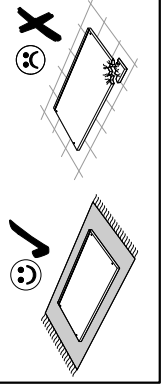
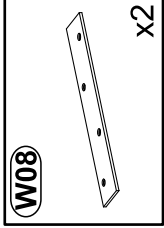
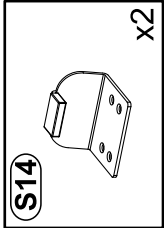
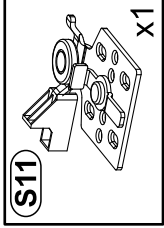
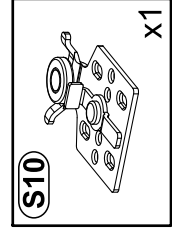

1

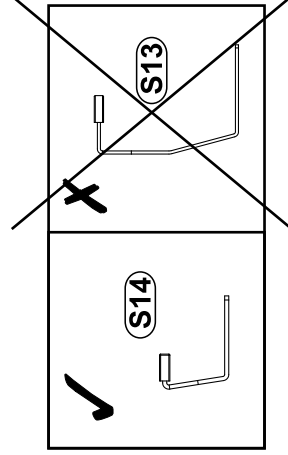
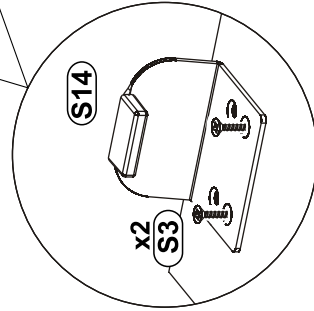
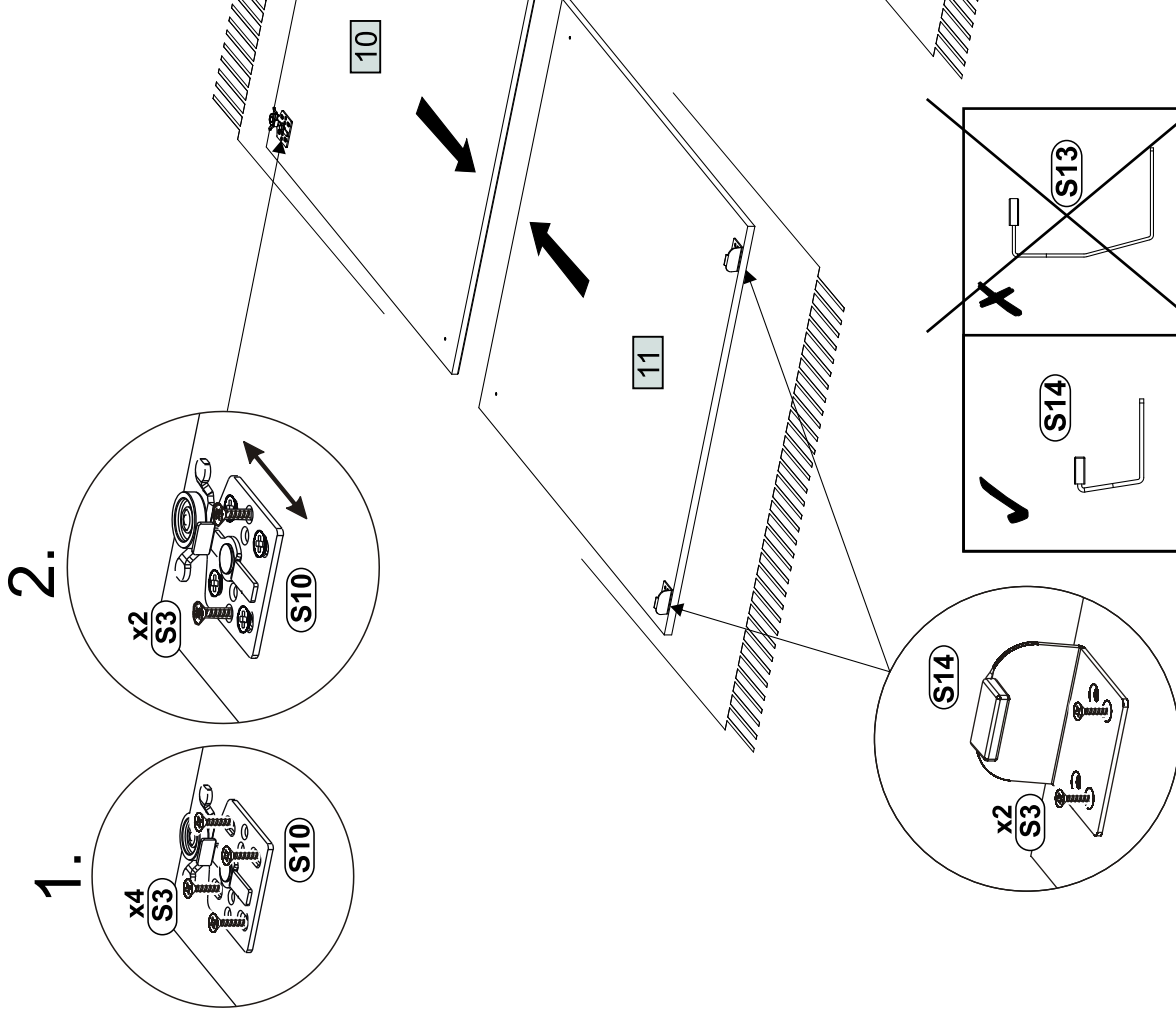
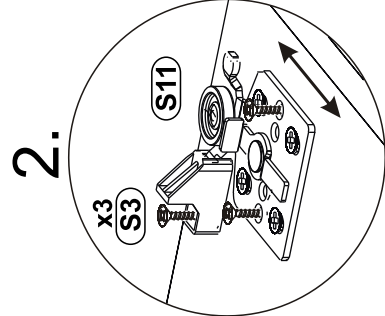
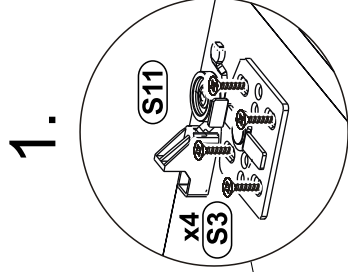
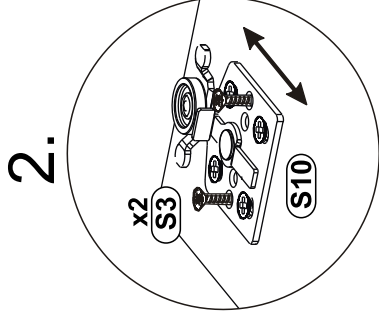
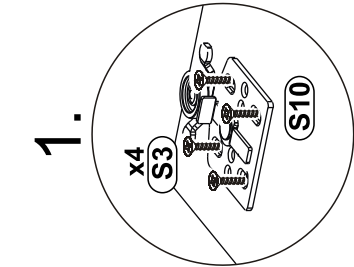

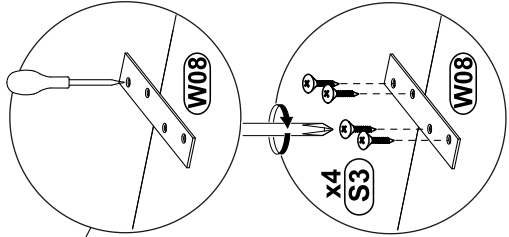
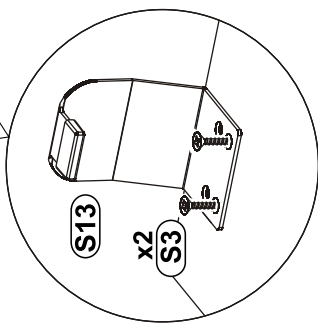
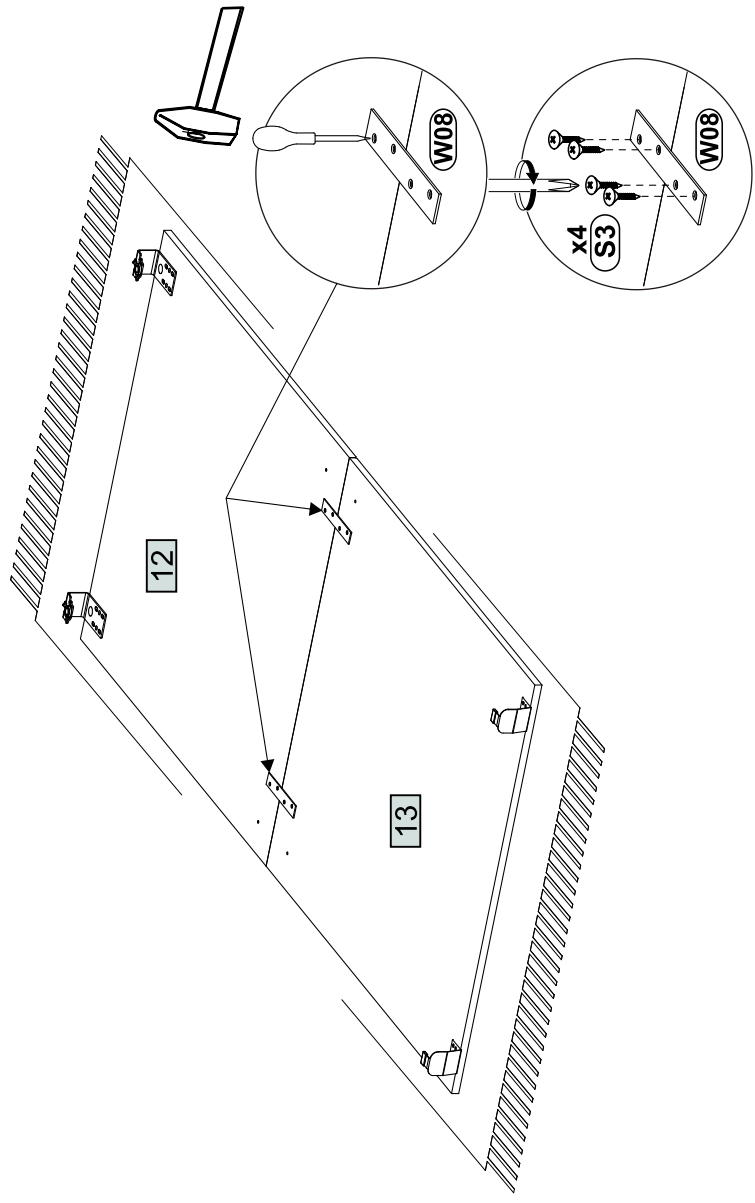
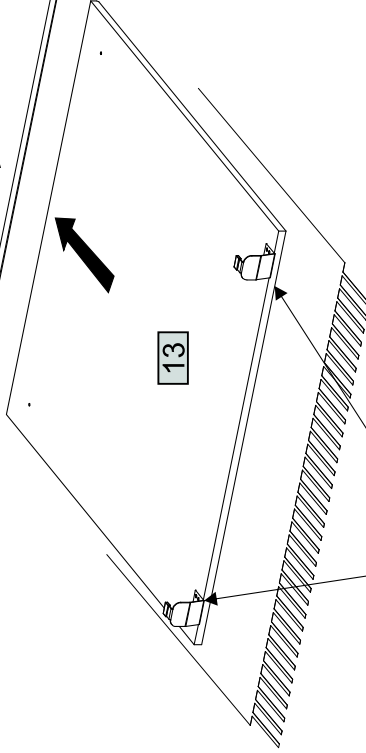
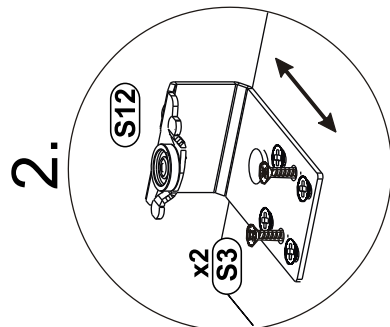
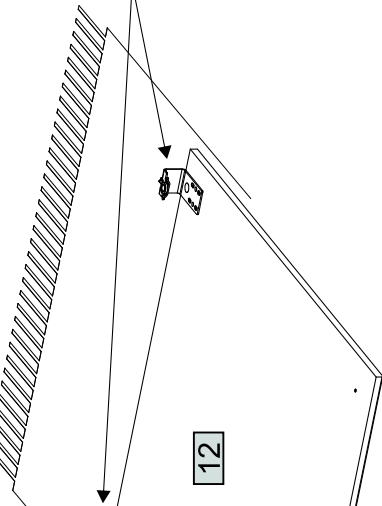
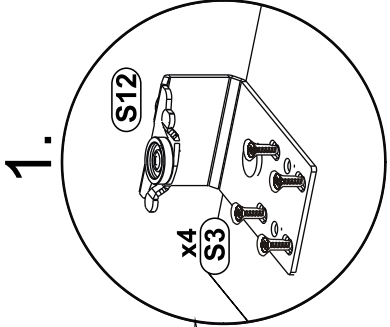
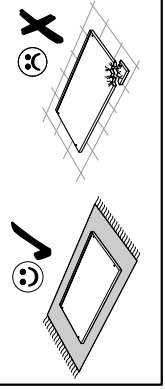
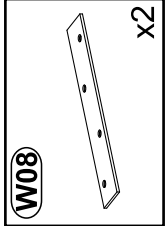
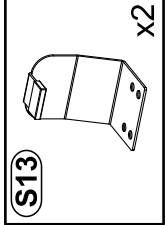
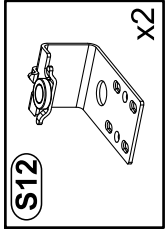

2

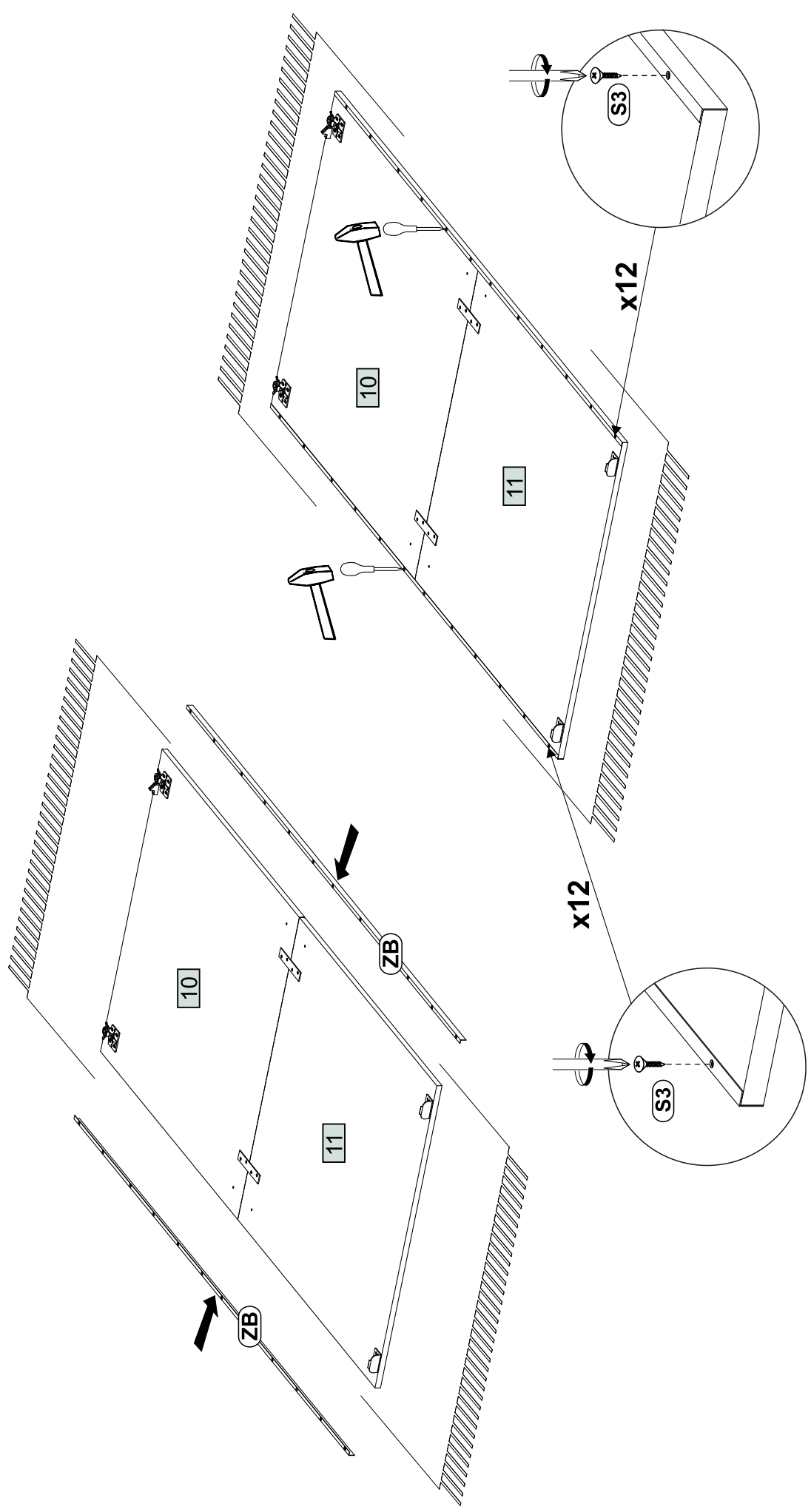
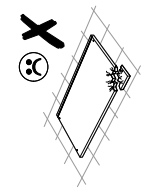
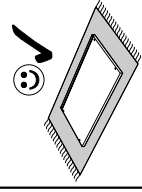
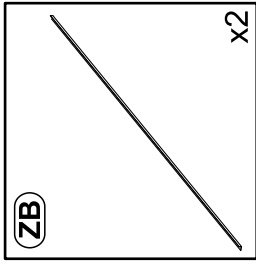

3



4

- A14**  **x2**
- M4x22**  **x2**
- U70**  **x1**

3.

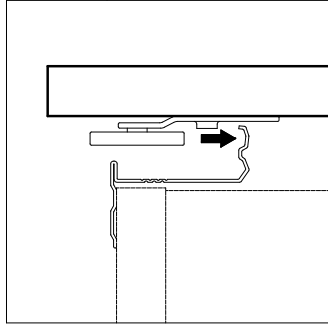

1.

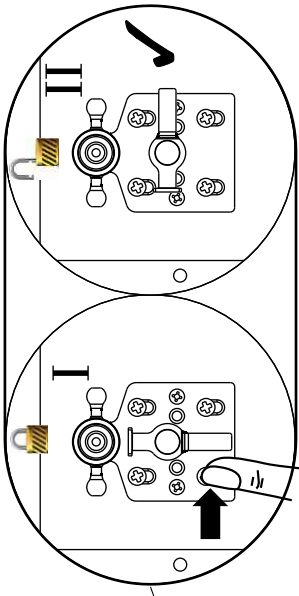

4.

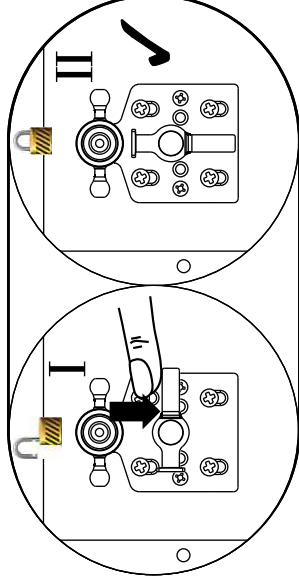

5.

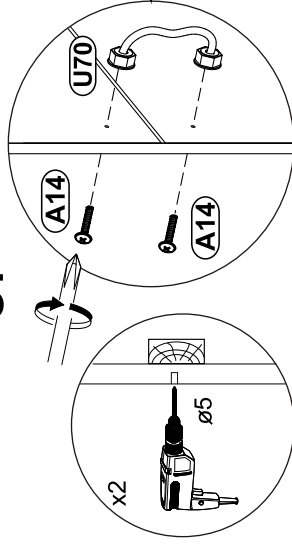

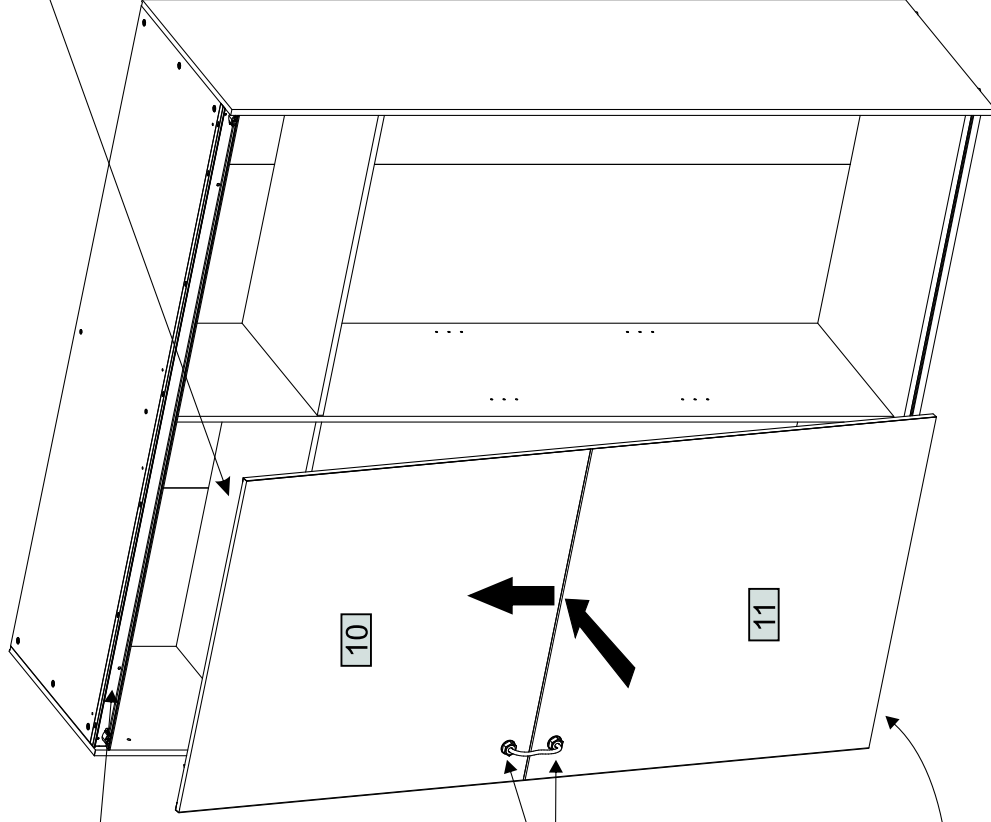
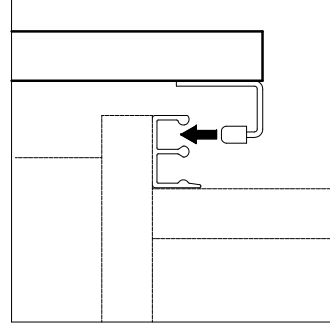

2.

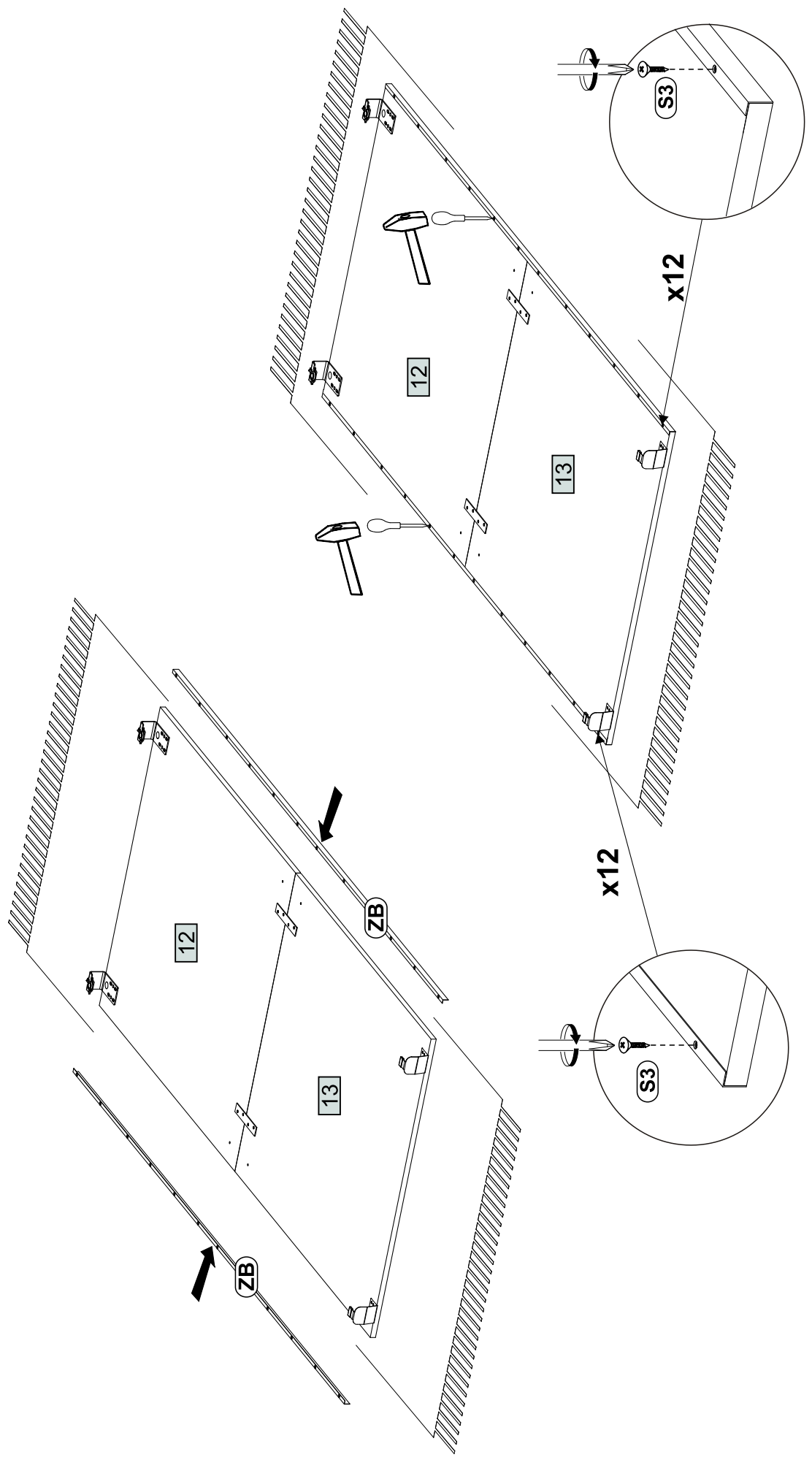
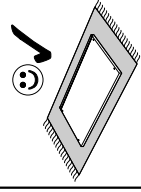
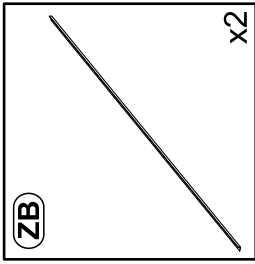

5



6

- A14**  M4x22 x2
- U70**  x1

3.

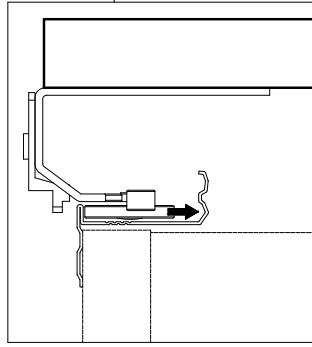

2.

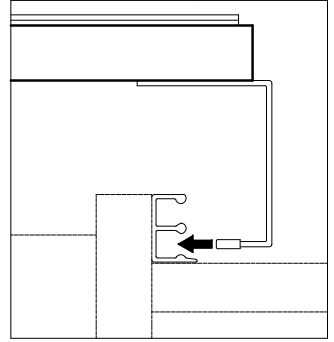

1.

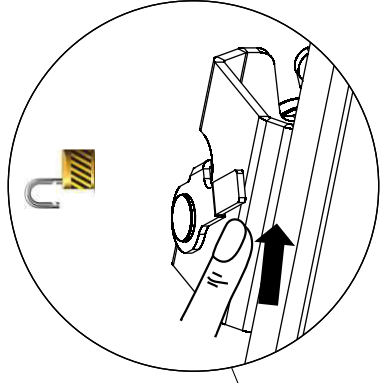

4.

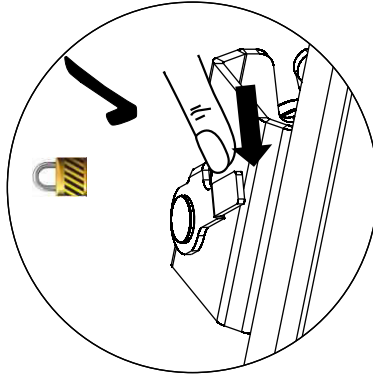

5.

