

Montageanleitung
Assembly instruction
Instructions de montage
Instrucciones de montaje
Istruzioni per il montaggio
Руководство по монтажу
Instrukcja montażu
Montážní návod
Návod na montáž
Szerelési utasítás
Инструкция за монтаж
Kurulum Talimatları
Navodilo za montažo
Montagehandleiding
A s e n n u s o h j e
Upute o montaži
Instrucțiuni de montaj
Monteringsveiledning

إرشادات التركيب

Monteringsvejledning
Instruções de montagem
Monteringsanvisning

Beschläge / fittings / Ferrures pour meubles / Herrajes / Guarnizioni / Крепления / Okucia / Kování /Kovanie / Vasalások / обков / Parçaları /okovje / Hang- en sluitwerk / helat / Oblo-ge / armături, balamale / Beslag / بعض التركيبات / Beslag / Guarnições / Beslag

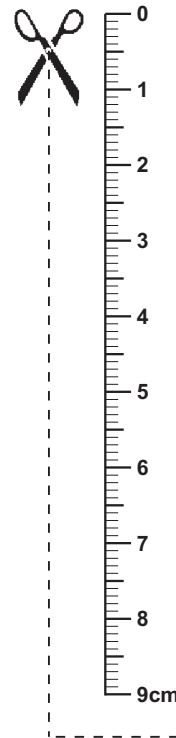
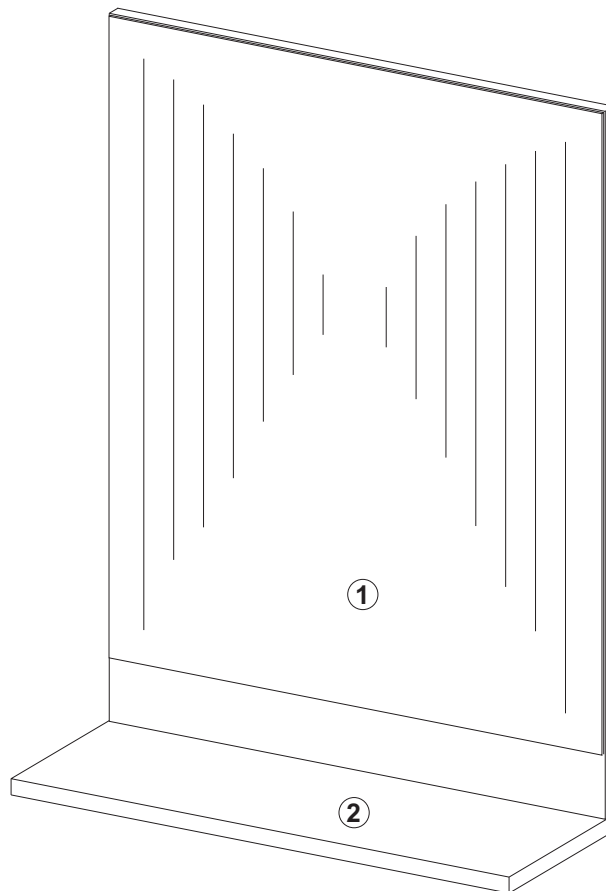
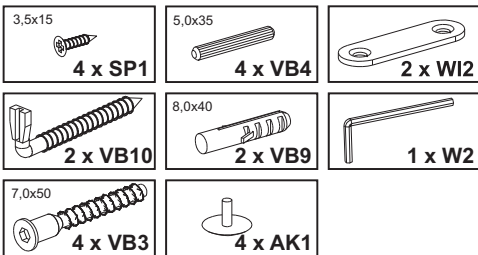

Sie benötigen:
 You need:
 Vous avez besoin de:
 Necesita:
 Le servono :
 Вам потребуются:
 Potrebujete:
 Tarvitset:
 Aveți nevoie de :
 Du behøver:
 سوف تحتاج إلى:

Potrzebne są:
 Potřebujete:
 Potrebujete:
 Szükséges eszközök:
 На Вас са Ви нужни:
 Ihtiyacınız:
 U hebt nodig:
 Trebate:
 Du skal bruge:
 Necesita de:
 Du behöver:

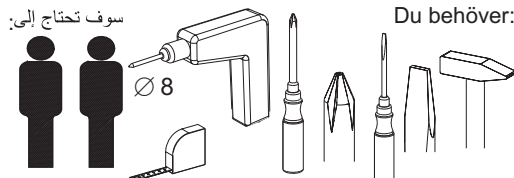

Teile / article / Pièces / Piezas / Pezzi / части / Części / Díly / Diely / Alkatrészek / Детали / parçalar / dele / Onderdelen / osat / Dijelovi
 piese / Deler / والتجهيزات / Dele / Peças / Delar

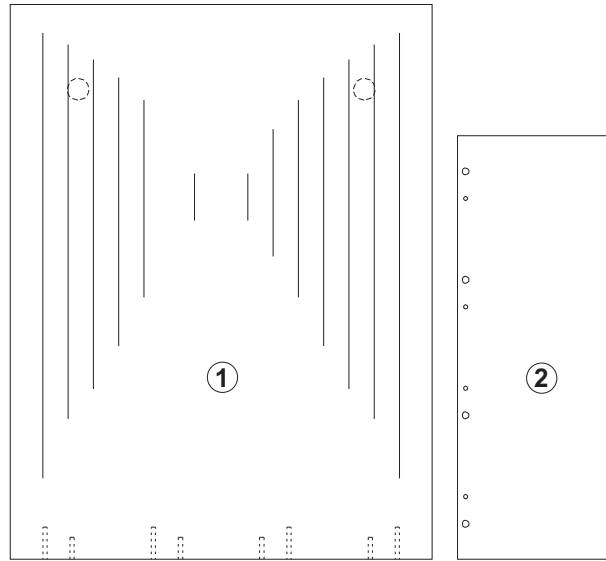

A

3,5x15

 4 x SP1

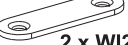
5,0x35

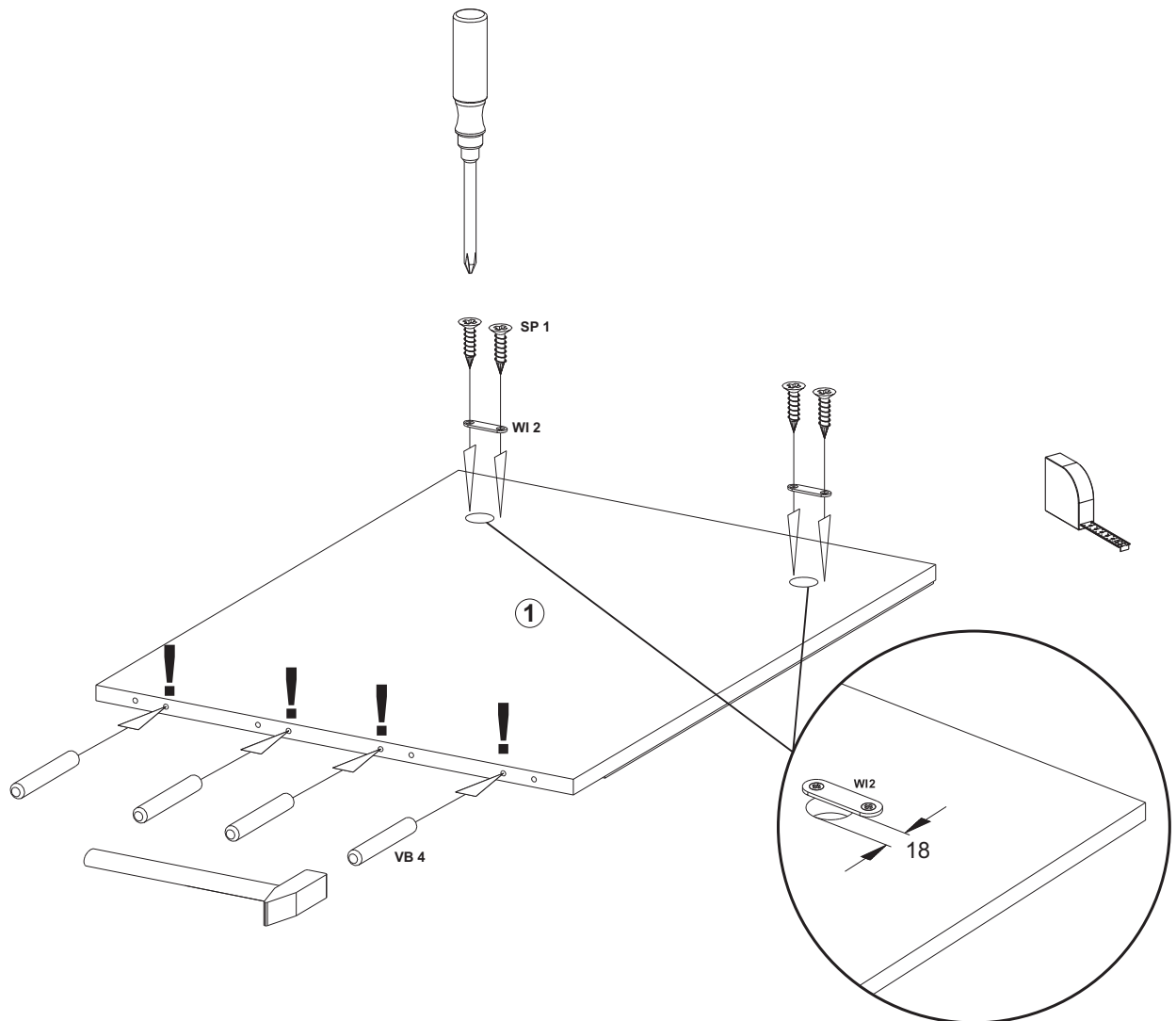
 4 x VB4

 2 x WI2

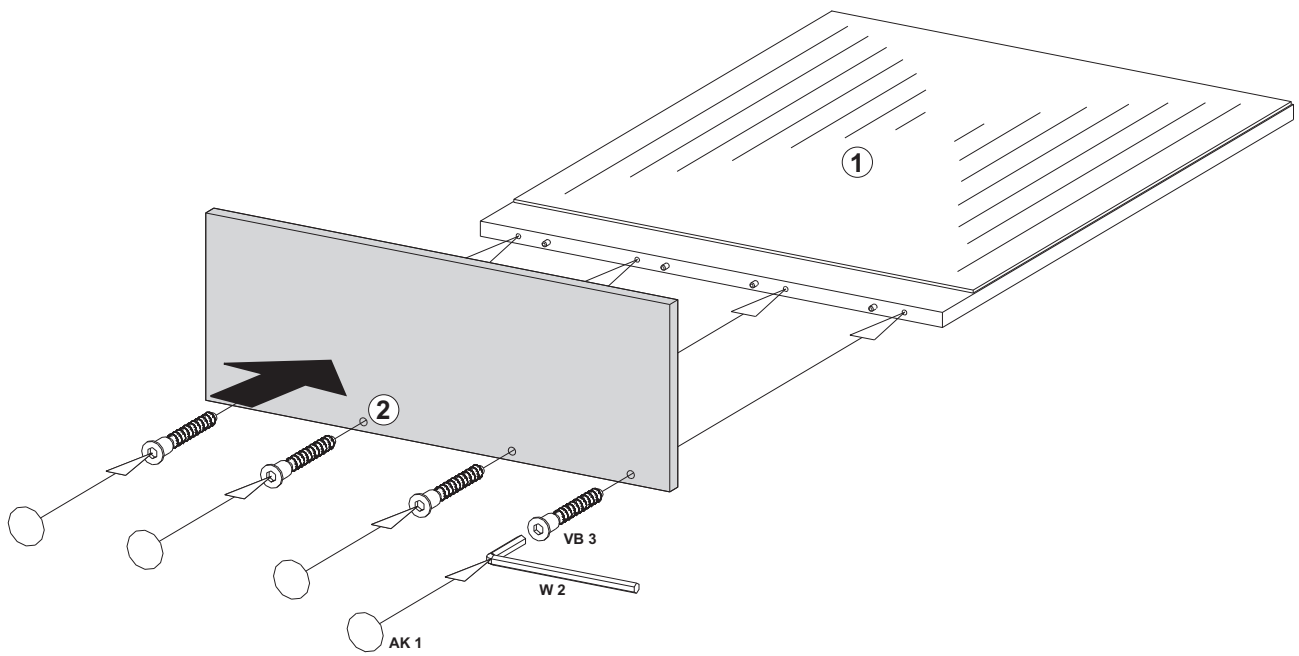
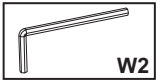
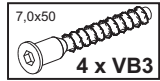
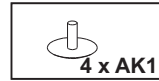

B



C

