

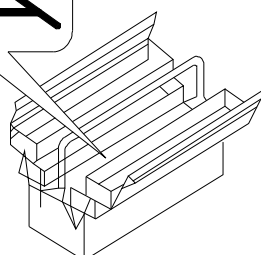

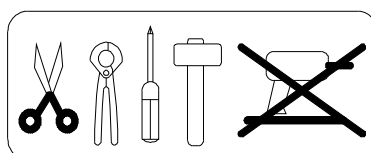

- | | |
|---------------------------------------|-----------------------------------|
| D Montageanleitung | GB Assembly instructions |
| NL Handleiding voor de montage | PL Instrukcja montazu |
| TR Montaj talimati | RU Инструкция по монтажу |
| FR Notice de montage | IT Istruzioni di montaggio |
| CS Montážní návod | SK Návod na montáž |
| HU Szerelési útmutató | RO Instrucțiuni de montaj |

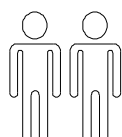
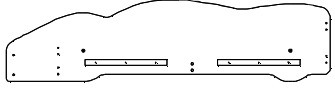
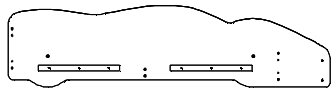

SCTDPOL

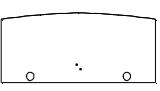
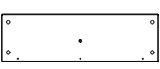
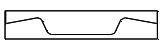
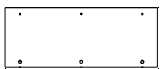
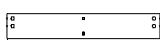
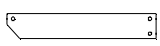
ITEM NO.	MEASUREMENT	QTY	SHAPE	CARTON NO.
①	1730 X 400 X 27	X1		1-1
②	1730 X 400 X 27	x1		1-1
③	720 X 350 X 12	x1		1-1
④	716 X 300 X 15	x1		1-1
⑤	720 X 200 X 12	x1		1-1
⑥	720 X 128 X 24	x1		1-1
⑦	720 X 259 X 12	x1		1-1
⑧	720 X 108 X 15	x1		1-1
⑨	702 X 108 X 15	x2		1-1
⑩	292 X 292 X 18	x4		1-1
⑪	718 X 354 X 12	x4		1-1

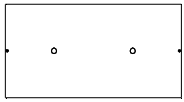
1420x720

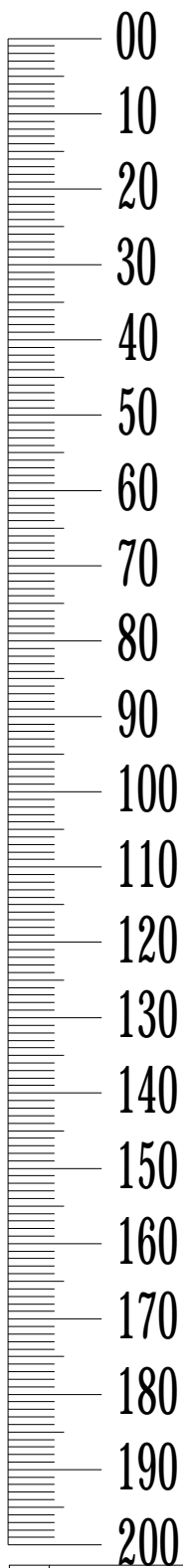



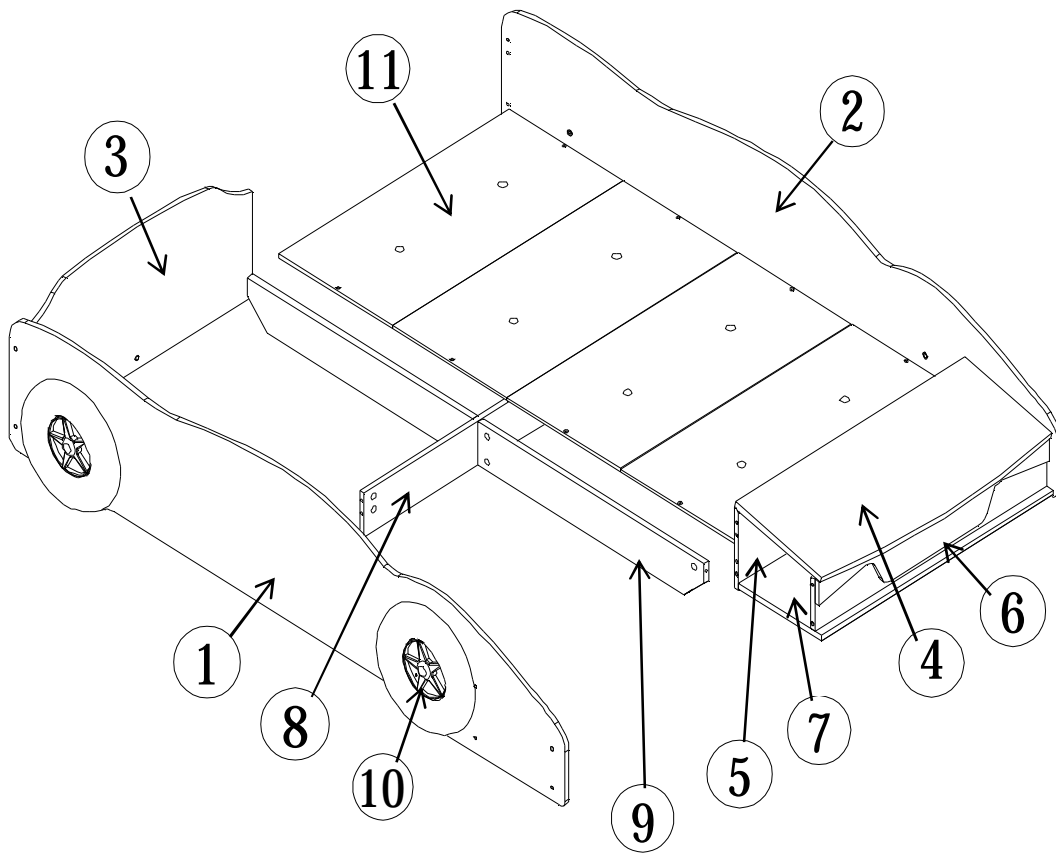

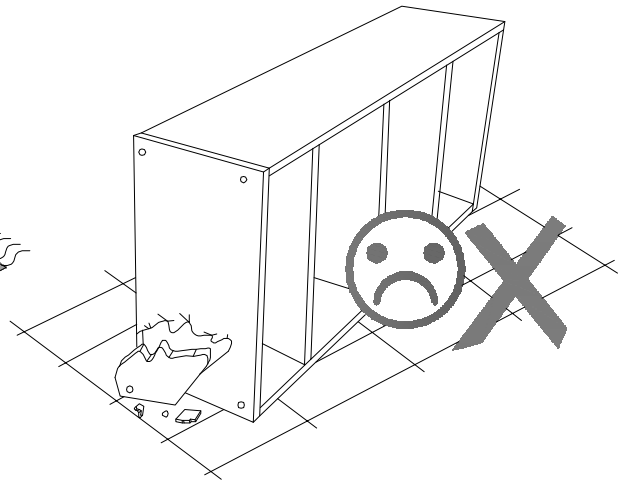
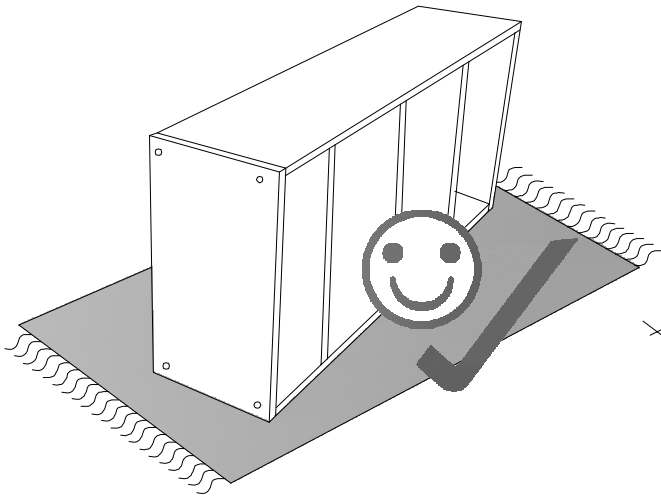

Service • Asistenza • Dienstverlening • Serwis Servis • Szerviz • Сервисная служба	
Name • Nom • Nome • Naam • Nazwa • Jméno • Názov • Név • Denumire • Isim • Название	
Nr. • No. • N° • Номер • Číslo • Sz	
Тур • Type • Típus • Tipus • Típo • Тип	





- | | | | | | |
|--------------------|----------------------|---------------------|--------------------|------------------|-------------------|
| A x10 | B x6 | C 6x30 x8 | D1 10x9 x12 | D2 9x9 x6 | E1 6x20 x4 |
| E2 6x50 x12 | F1 3.5x12 x20 | F2 3.5x29 x8 | G x1 | H x2 | I 5x50 x6 |
| J x2 | K x8 | | | | |



1

B  x6	C  6x30 x8	D1  10x9 x12	D2  9x9 x6	E1  6x20 x4	F1  3.5x12 x8
---	--	--	--	---	---

G  x1

H  x2

K  x4

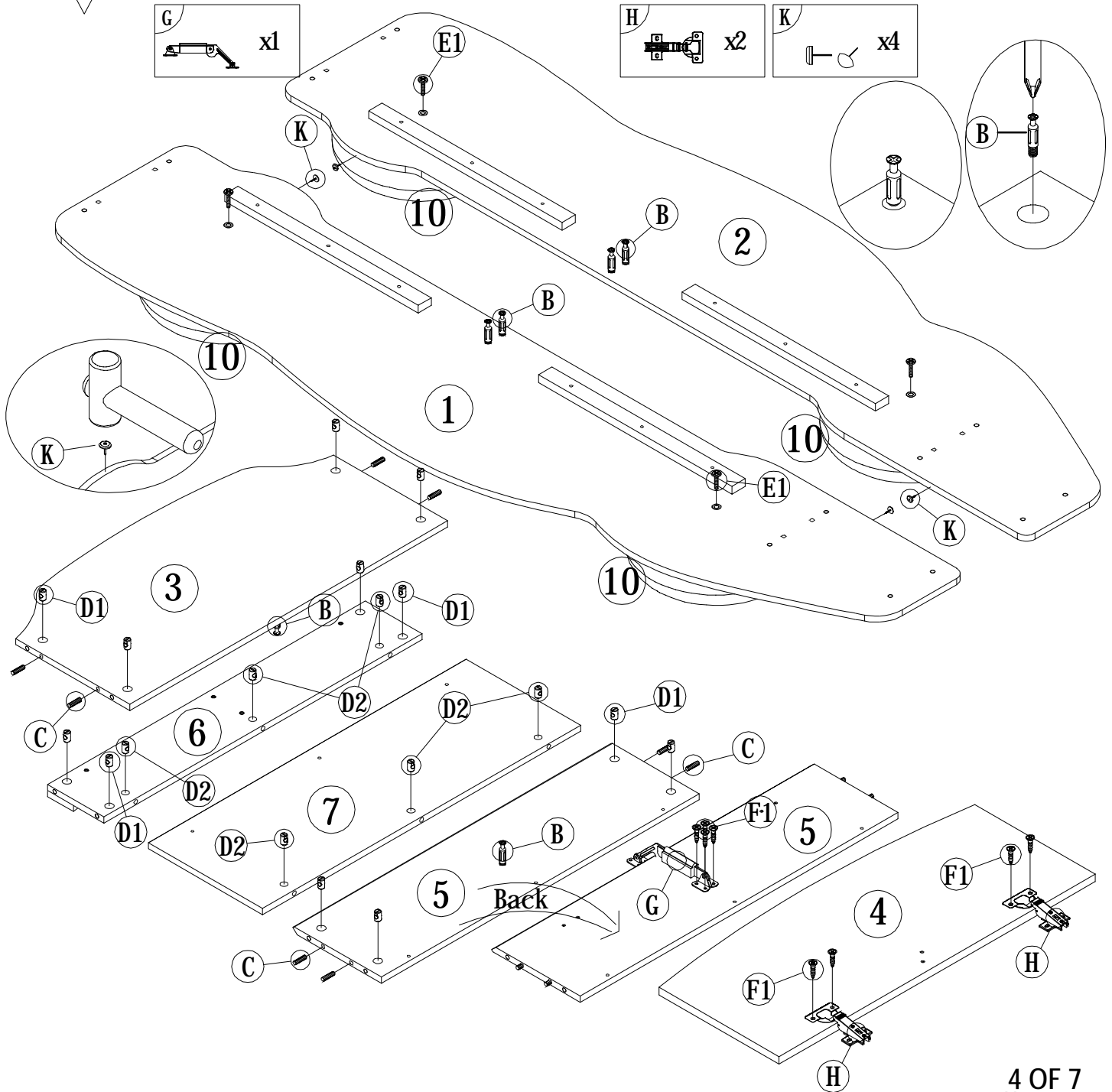

2

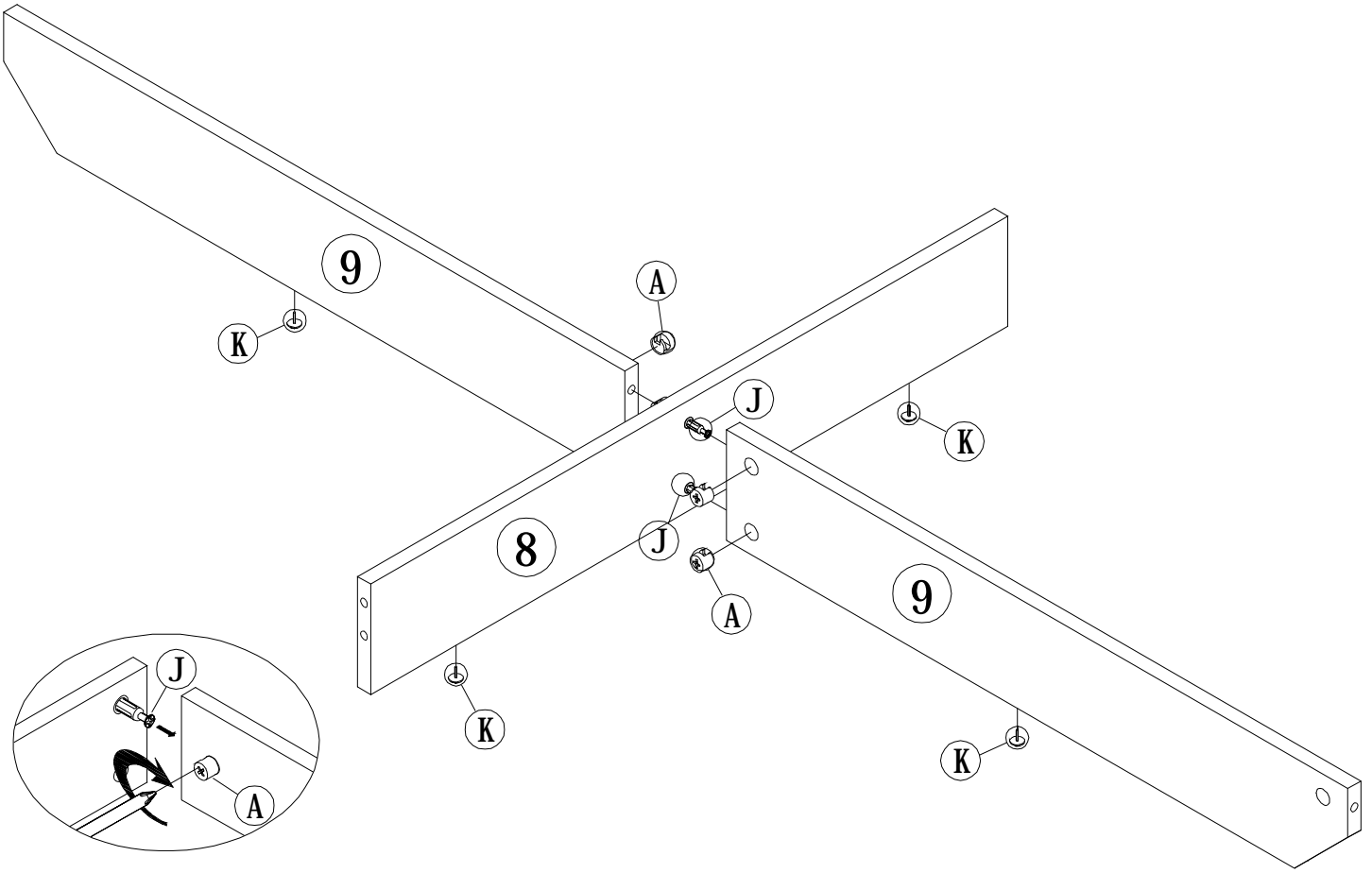
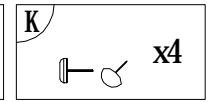
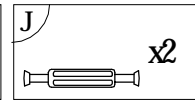
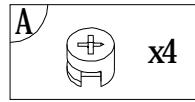

3

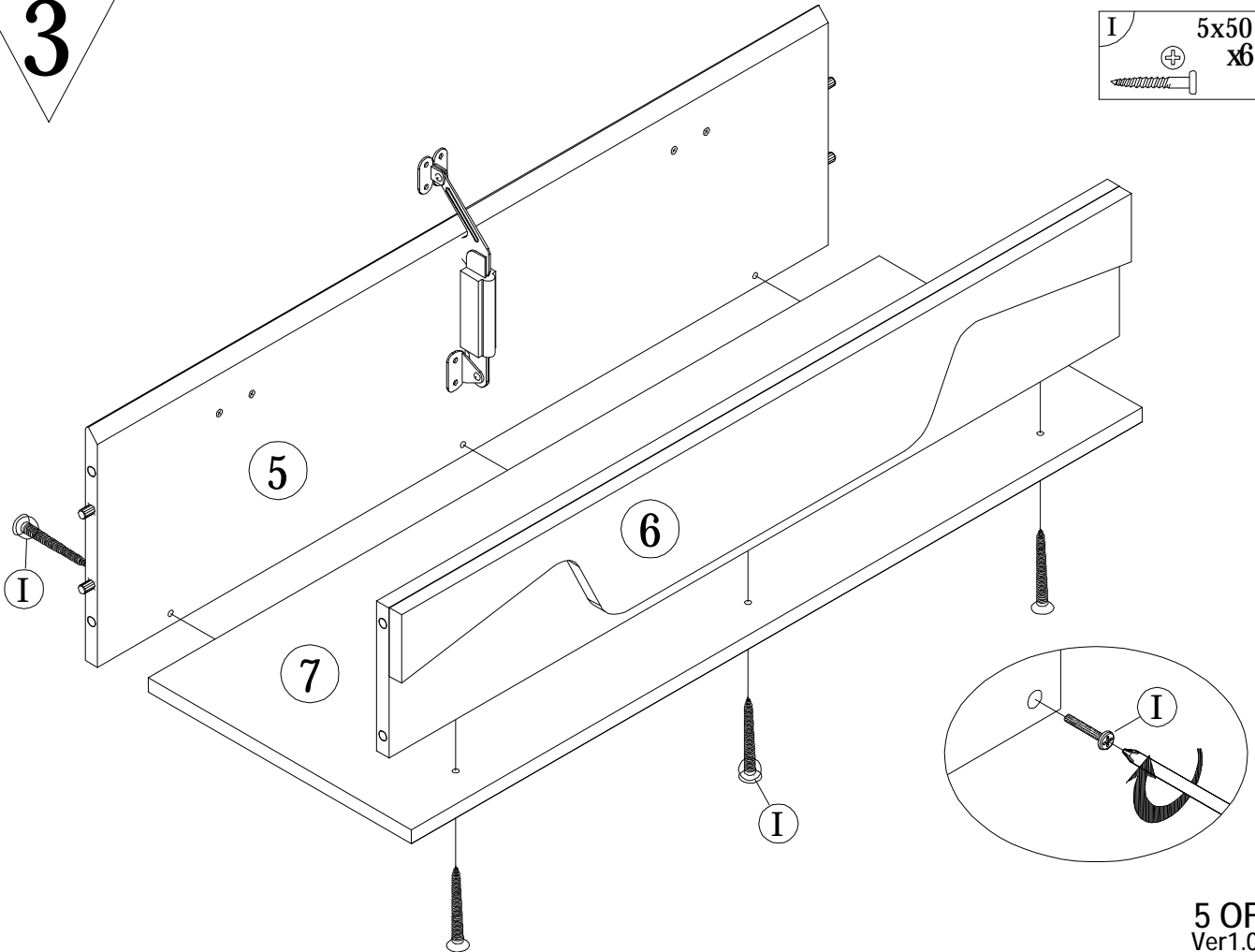
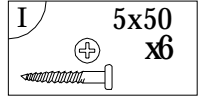

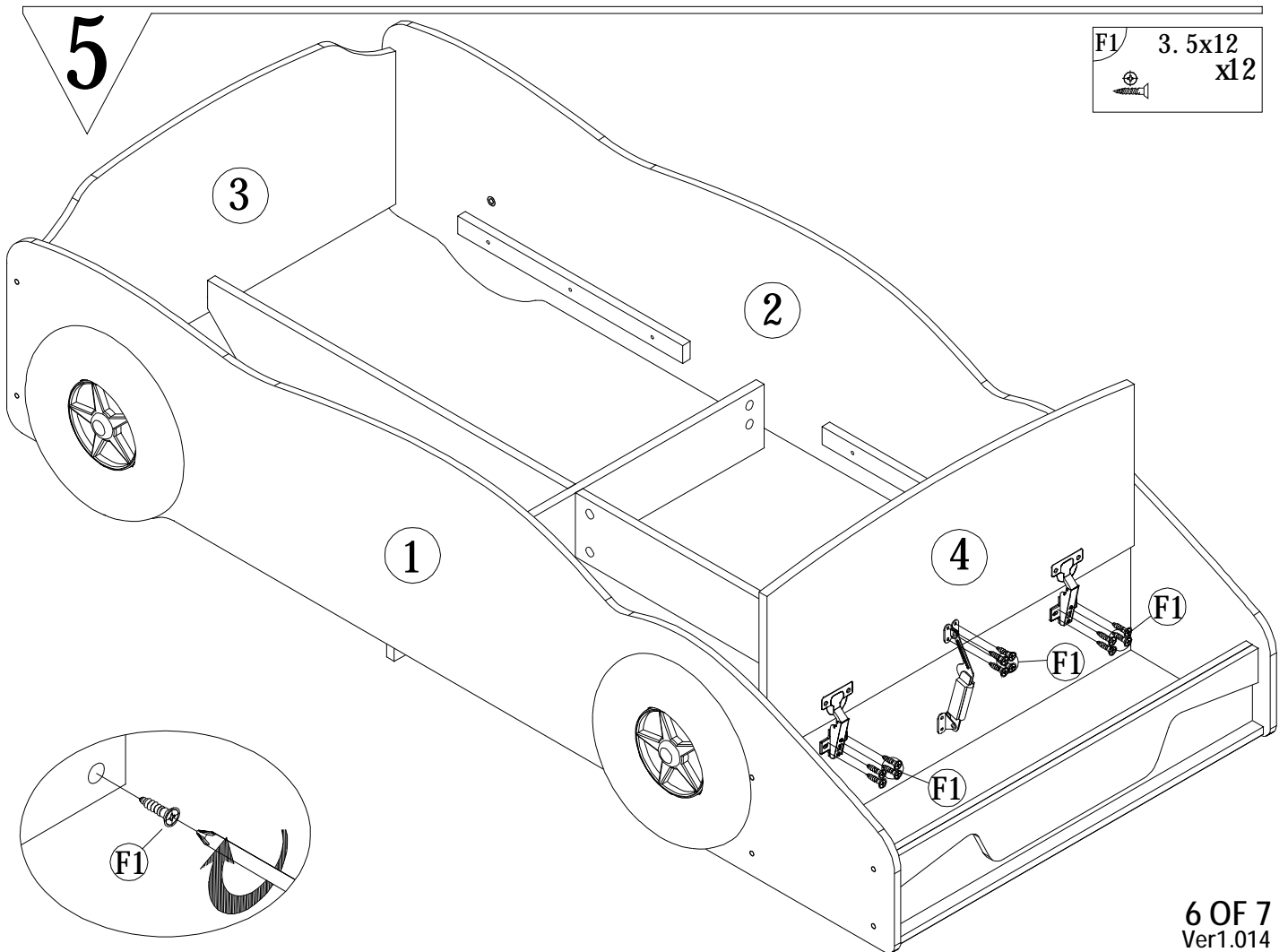
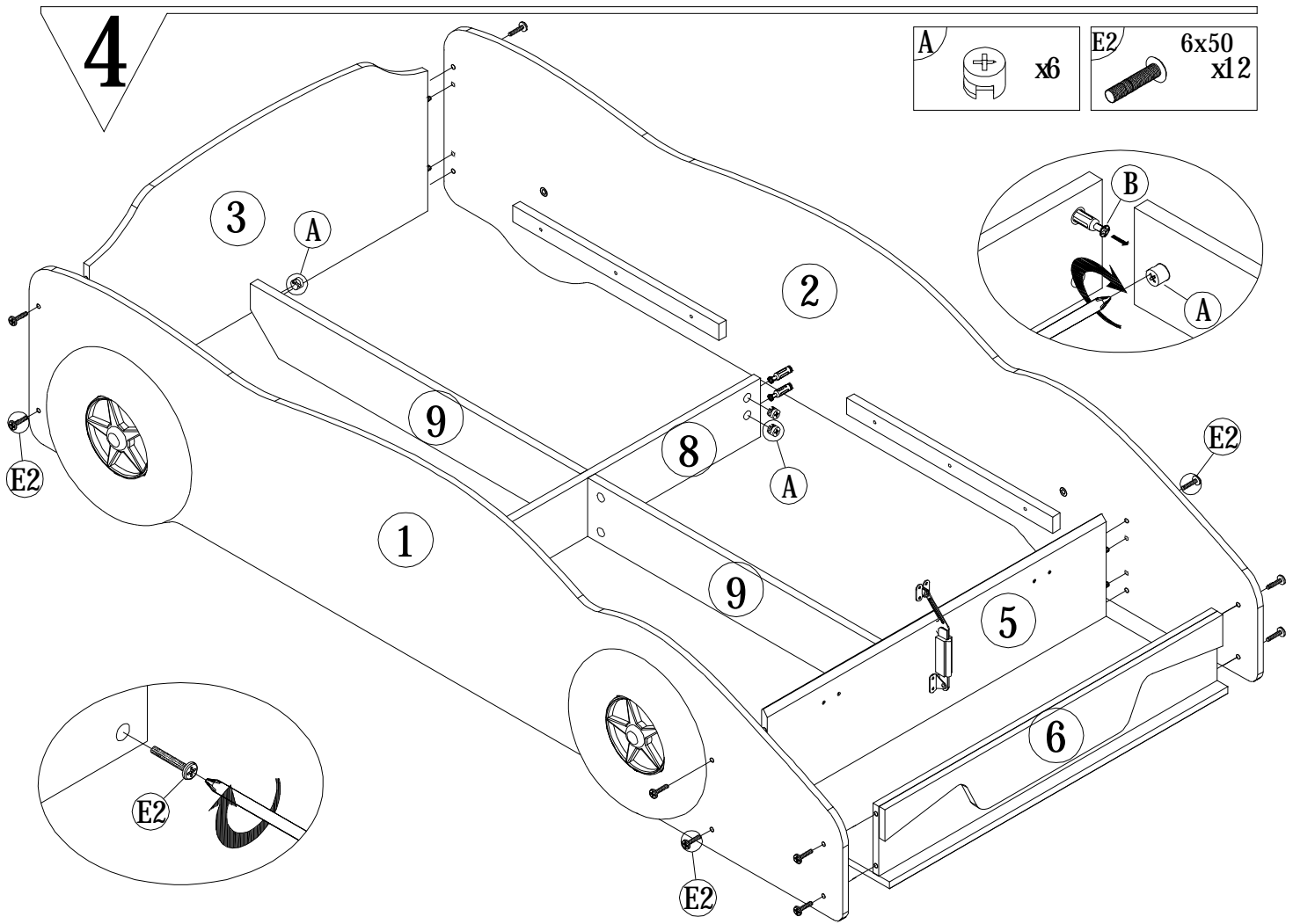

6

F2 3.5x29
x8

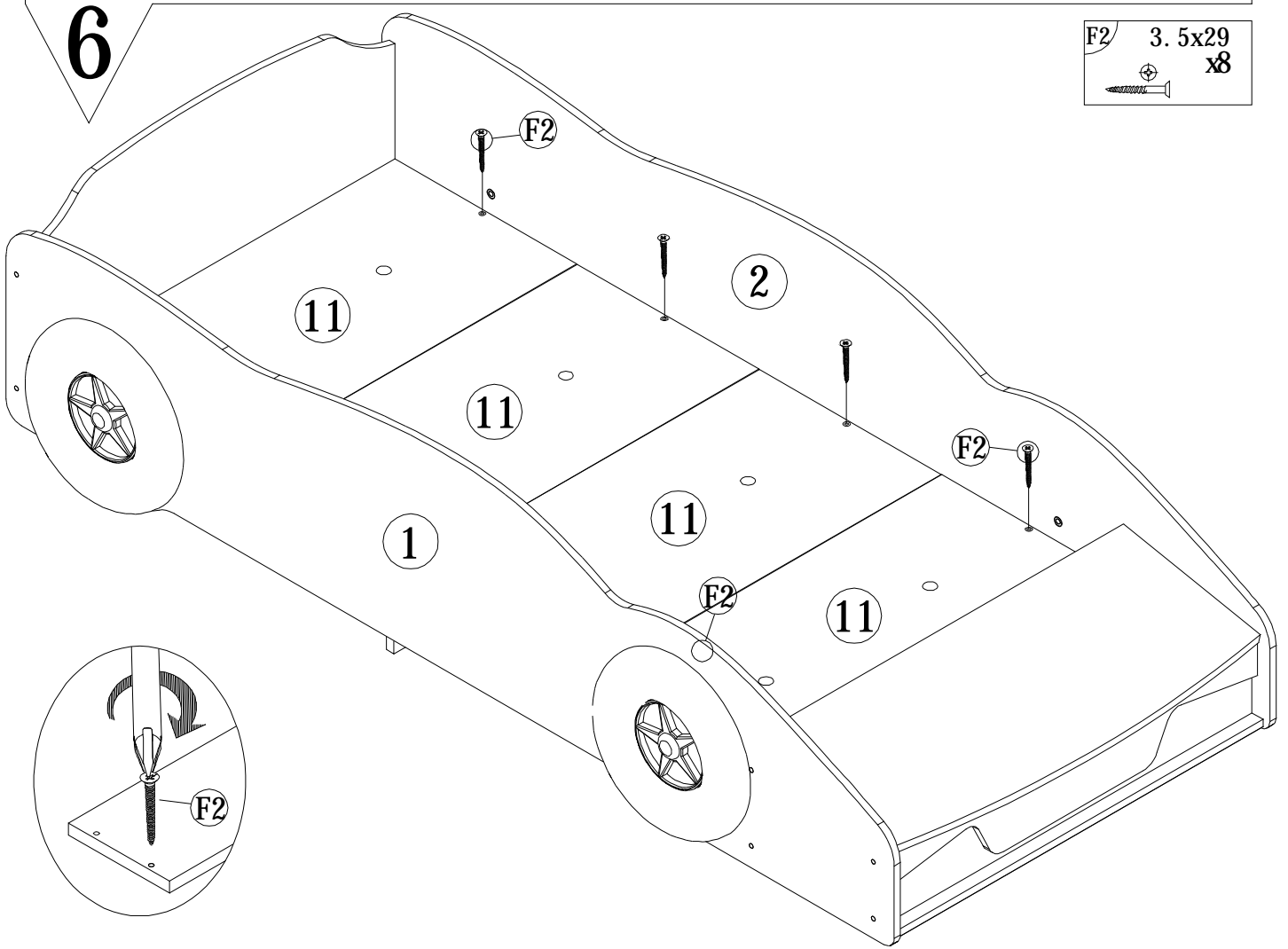

7

