

NEWBURY ASSEMBLY INSTRUCTION

9702 - 9703

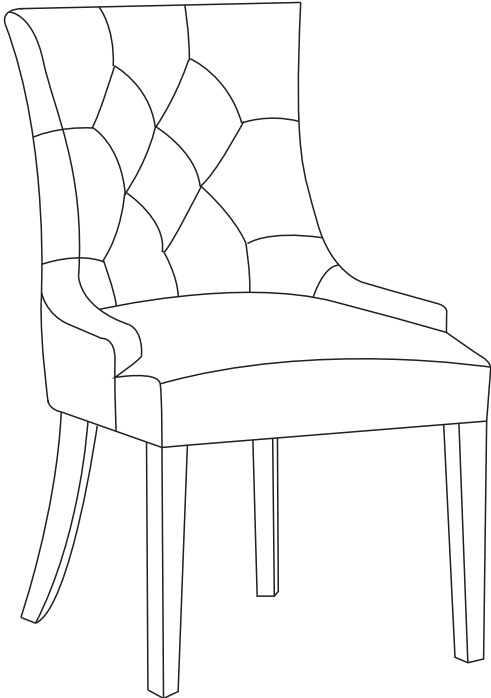

1

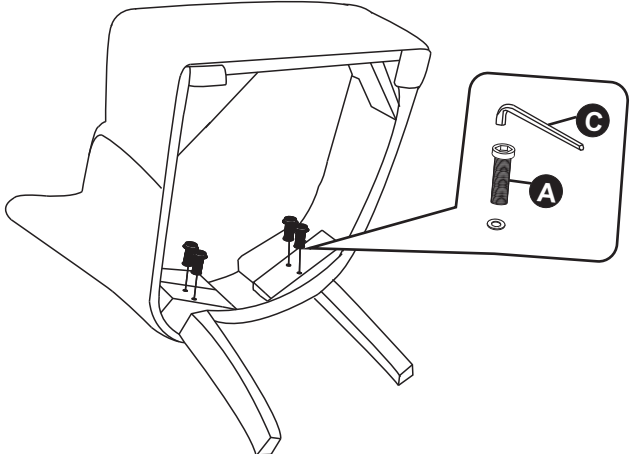

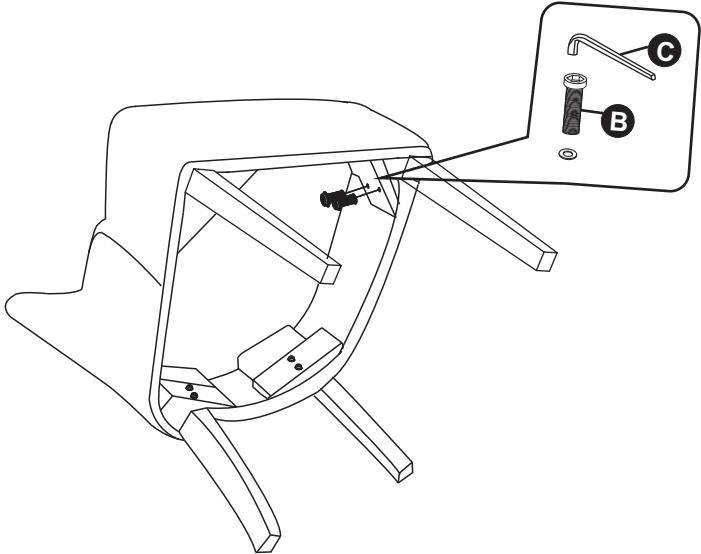

Put the screws in the holes, tight the screws, but not too tight, 90% is ok.

2

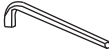

Put the screws in the holes, tight the screws, but not too tight, 90% is ok.

HARDWARE LIST	CODE	PARTS		QTY.
	A	M8x40MM		4
	B	M8x55MM		4
	C	ALLEN KEY		1

3

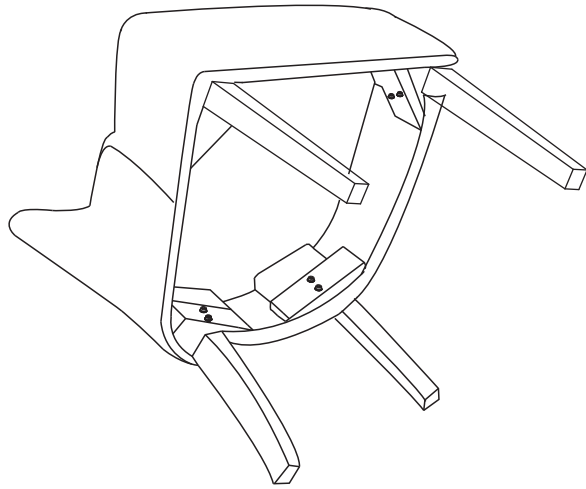

Tight all the screws to 100%

4

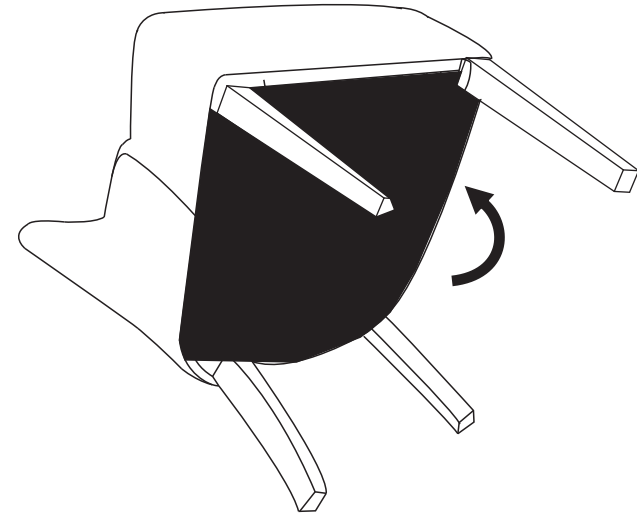

Stick the black part on the seat

CLEANING OF PU/LEATHER/FABRIC COVER-WIPE CLEAN WITH A SOFT CLOTH MOISTENED WITH WATER AND NEUTRAL DETERGENT. DO NOT USE BLEACH, CHEMICAL OR BIOLOGICAL CLEANERS

Screws need to be checked regularly and especially after first use.