

# SPIRIT

INDICE A - 15/07/2019

SPIRIT 36 VITRINE 1PO N°02 Réf: 19SC3910

SPIRIT 38 VITRINE 1PO N°02 Réf: 19SD3910

## NOTICE DE MONTAGE

ASSEMBLING INSTRUCTIONS

MONTAGEANLEIUNG

MANUAL DE MONTAJE

MONTAGEVOORSCHRIFT

INSTRUÇÕES DE MONTAGEM

ISTRUZIONI DI MONTAGGIO

ИНСТРУКЦИЯ ПО СБОРКЕ

Naputci za montažu



MEUBLE DESTINE A ETRE  
FIXE AU MUR



FURNITURE TO BE FIXED  
TO THE WALL

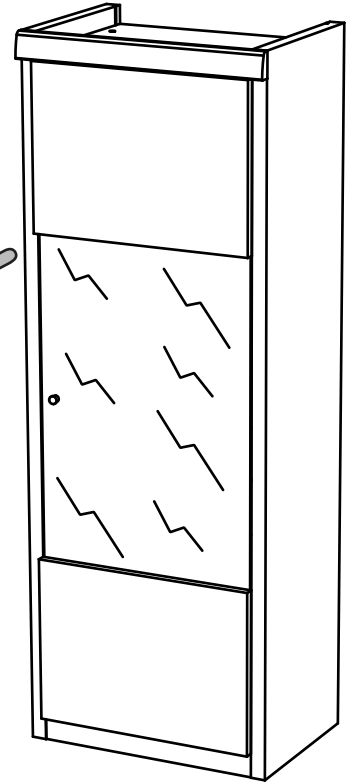
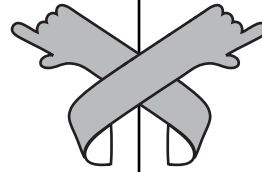
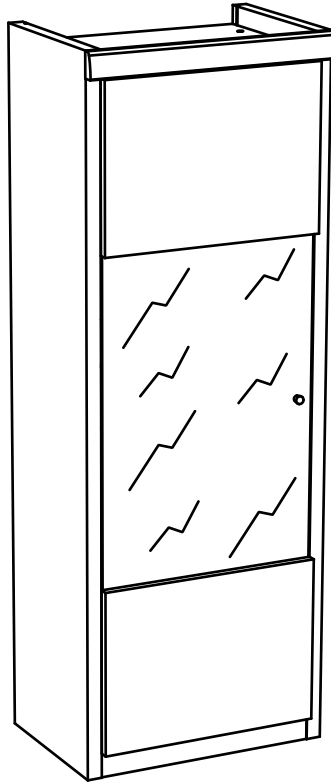

1H45

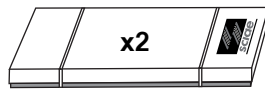

Package 1: 34 Kg  
Package 2: 40 Kg

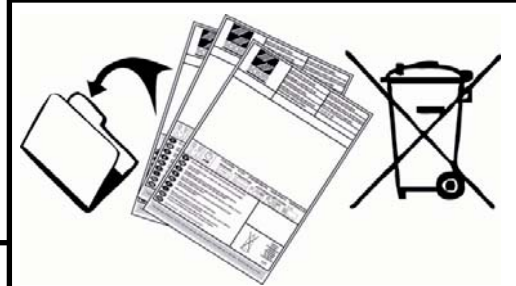

**F** POUR L'APRES-VENTE, RETOURNEZ AU MAGASIN AVEC CETTE NOTICE

**GB** FOR THE AFTER SALES, GO BACK TO THE SHOP WITH THIS ASSEMBLY INSTRUCTION

**D** WENDEN SIE SICH BITTE AN IHREN HANDLER UND GEBEN SIE IHM DIE KENNUMMER DES MOBELS UND DIE TEILNUMMER

**E** EN CASO DE SERVICIO POST-VENTA DEBEN DE VOLVER A LA TIENDA CON LAS INSTRUCCIONES DE MONTAJE

**NL** VOOR SERVICE NA VERKOOP, GA NAAR UW LEVERANCIER MET DEZE MONTAGE HANDLEIDING

**P** PARA O POS VENDA, VOLTE A LOJA COM ESTA FOLHA

**I** SERVIZIO POST VENDITA: E NECESSARIO PRESENTARSI SUL PUNTO VENDITA CON QUESTE ISTRUZIONI DI MONTAGGIO

**RU** ДЛЯ ПОСЛЕПРОДАЖНОГО ОБСЛУЖИВАНИЯ ПРОСЬБА ОБРАТИТЬСЯ В МАГАЗИН ПРЕДЪЯВИВ НАСТОЯЩУЮ ИНСТРУКЦИЮ ПО СБОРКЕ

**HR** U SLUČAJU REKLAMACIJE, VRATITE SE NA PRODAJNO MJESTO S OVIM UPUTAMA ZA MONTAŽU

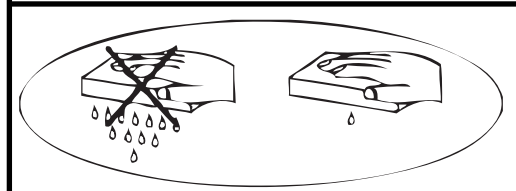

	+40°C +104°F	
	HYGROMETRIE HYGROMETRY 40%-65%	
	+15°C +59°F	

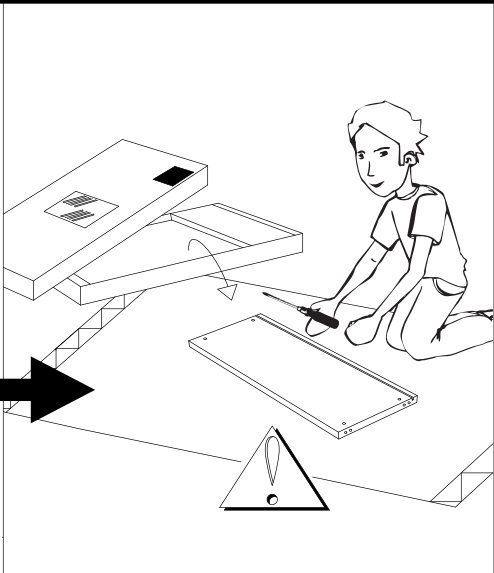
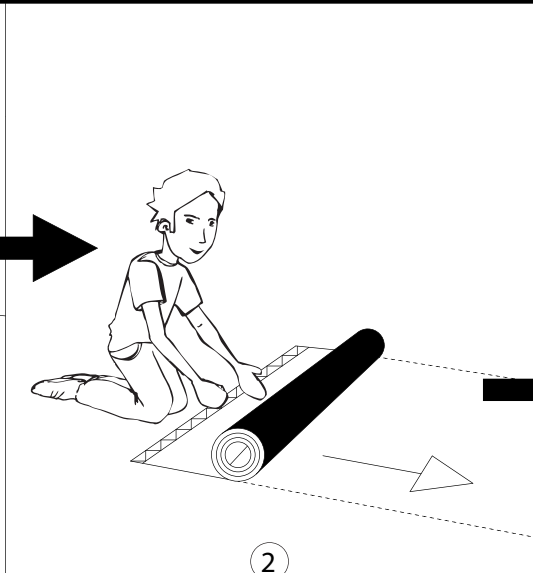
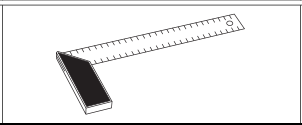
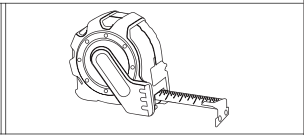
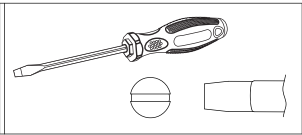
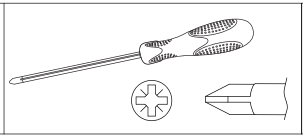
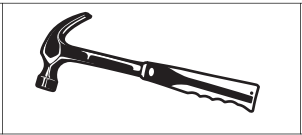
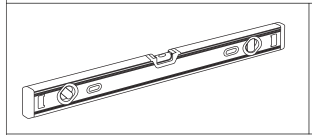
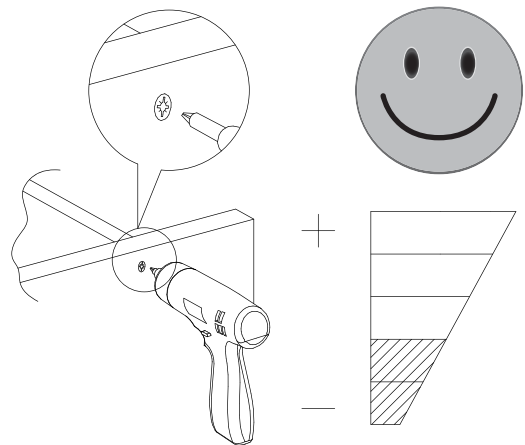
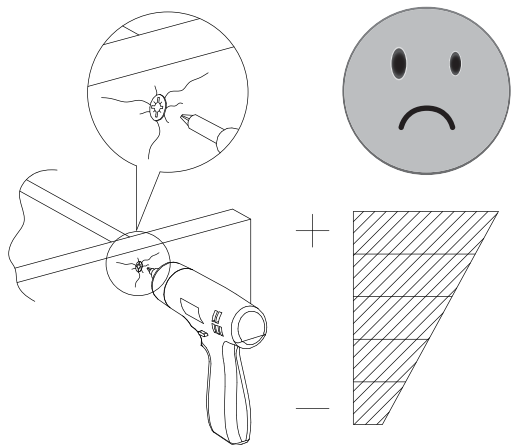
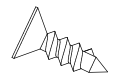
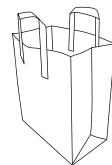
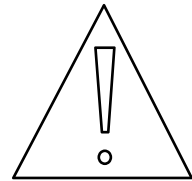
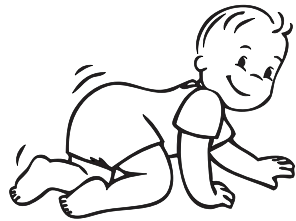

1 an  
1 year

OK

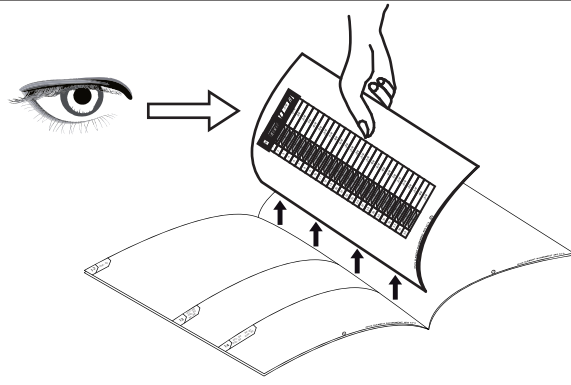

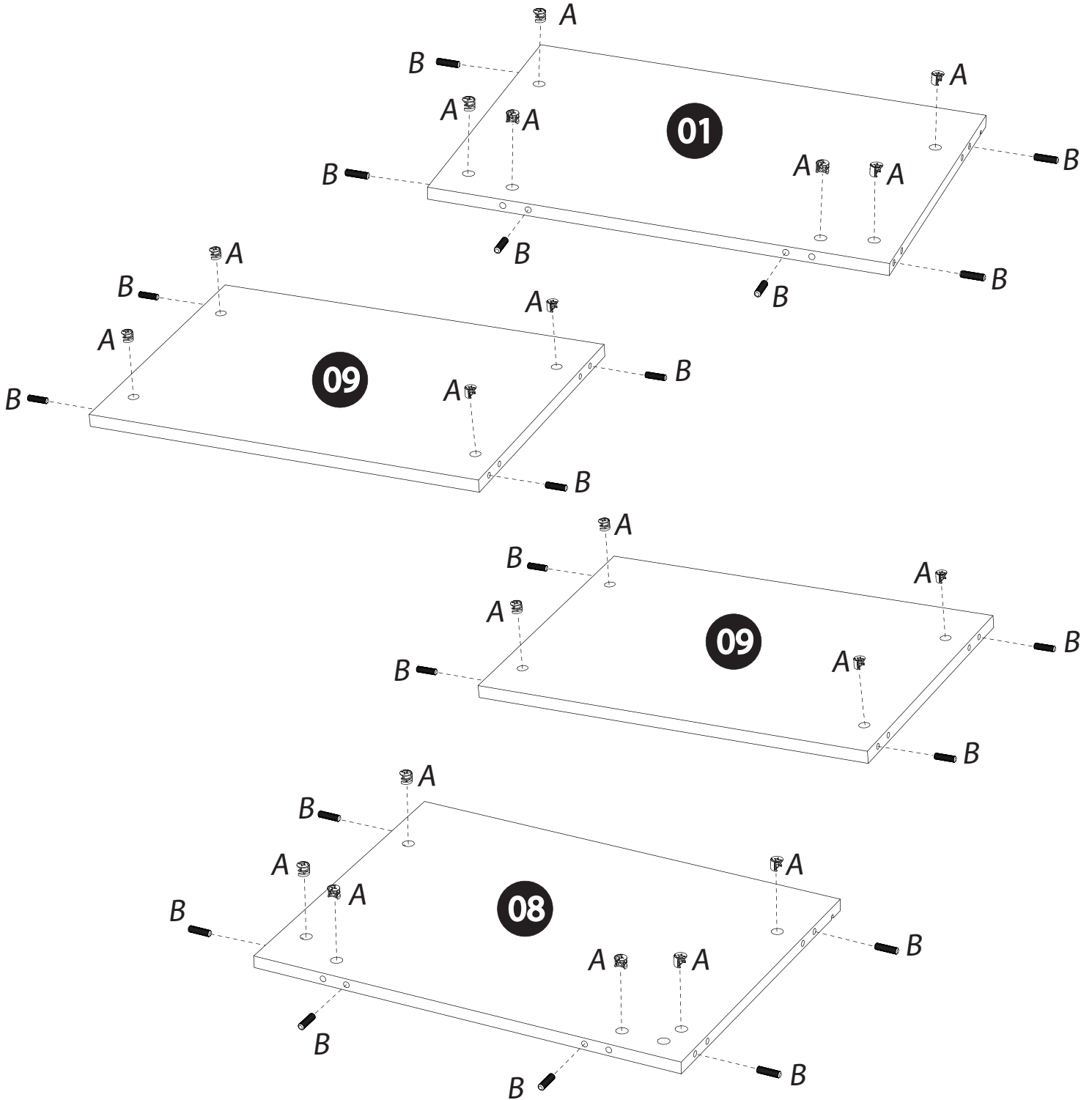
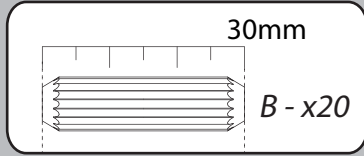
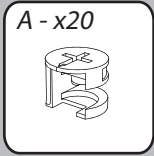

1



# 2

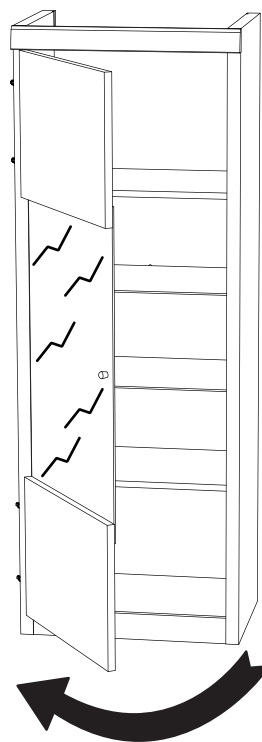
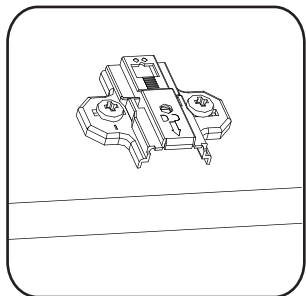
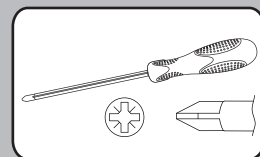
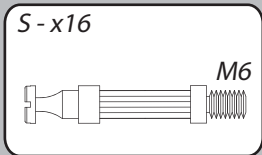
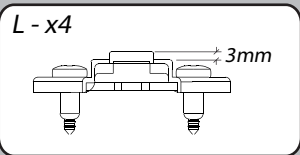

02

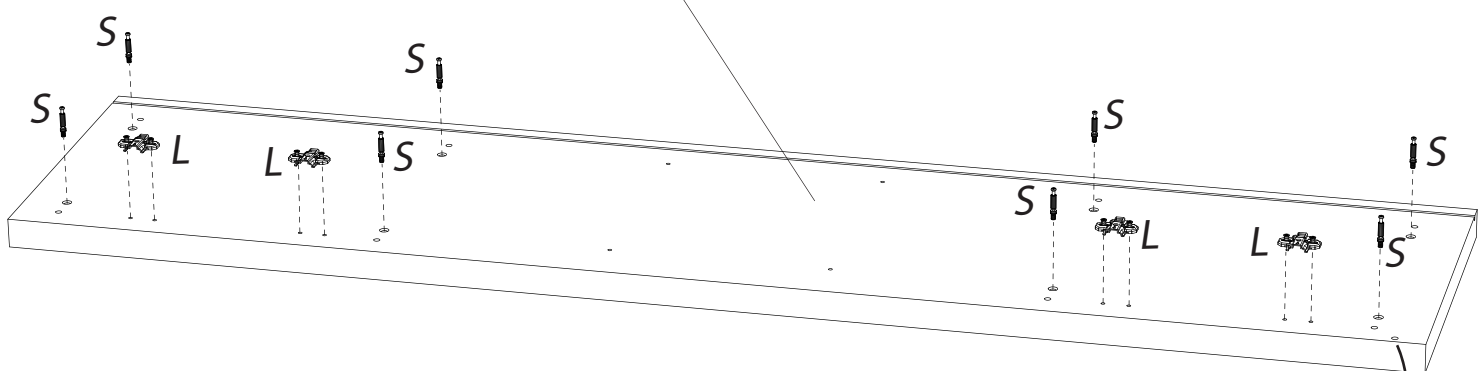

07

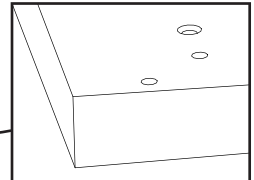
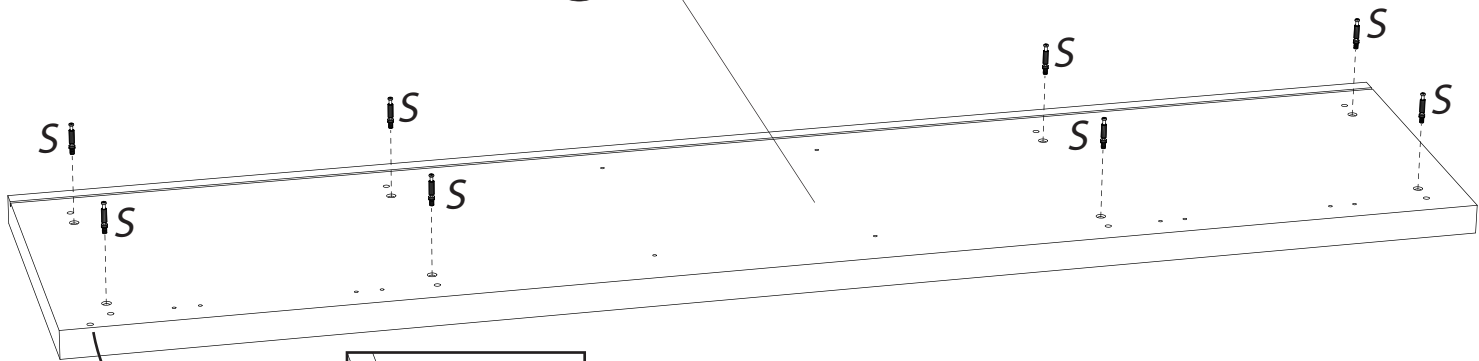

3

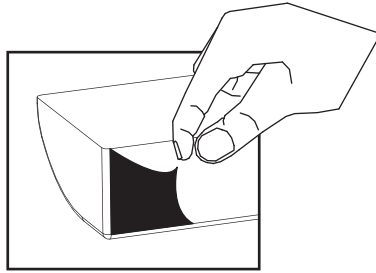
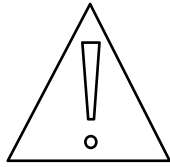
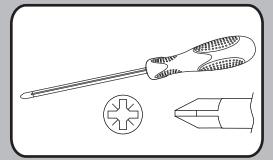
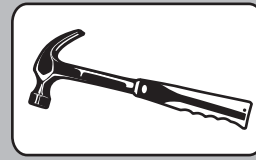
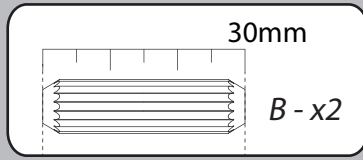
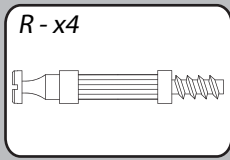

Pélicule de protection à retirer

18

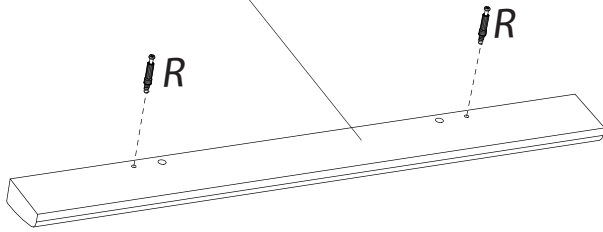

17

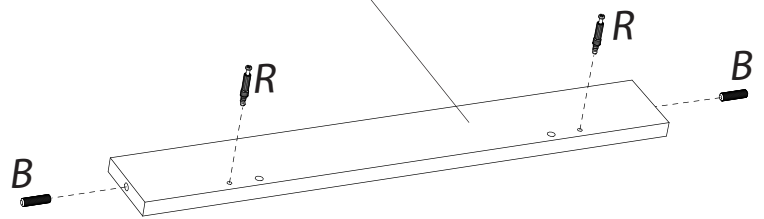

4

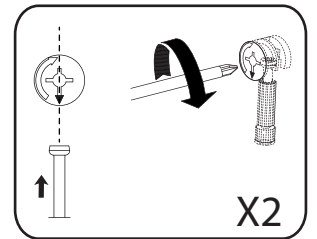
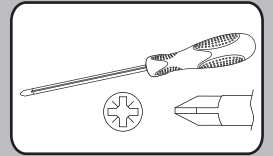

01

17

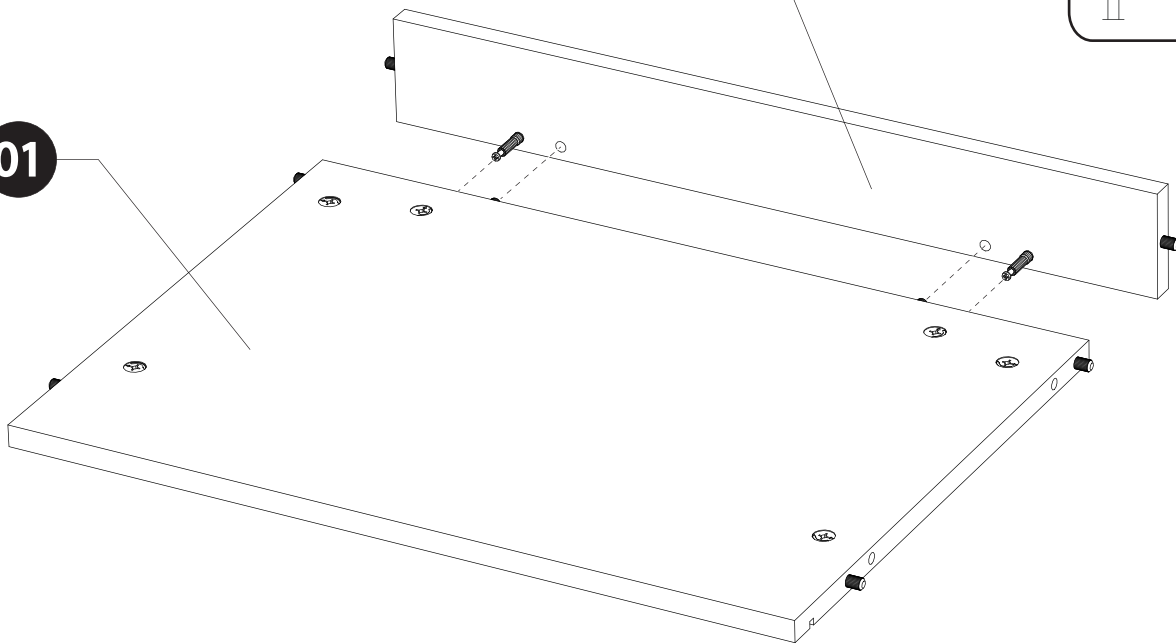

# 5

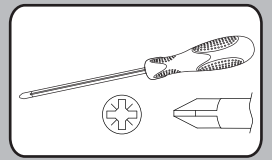

08

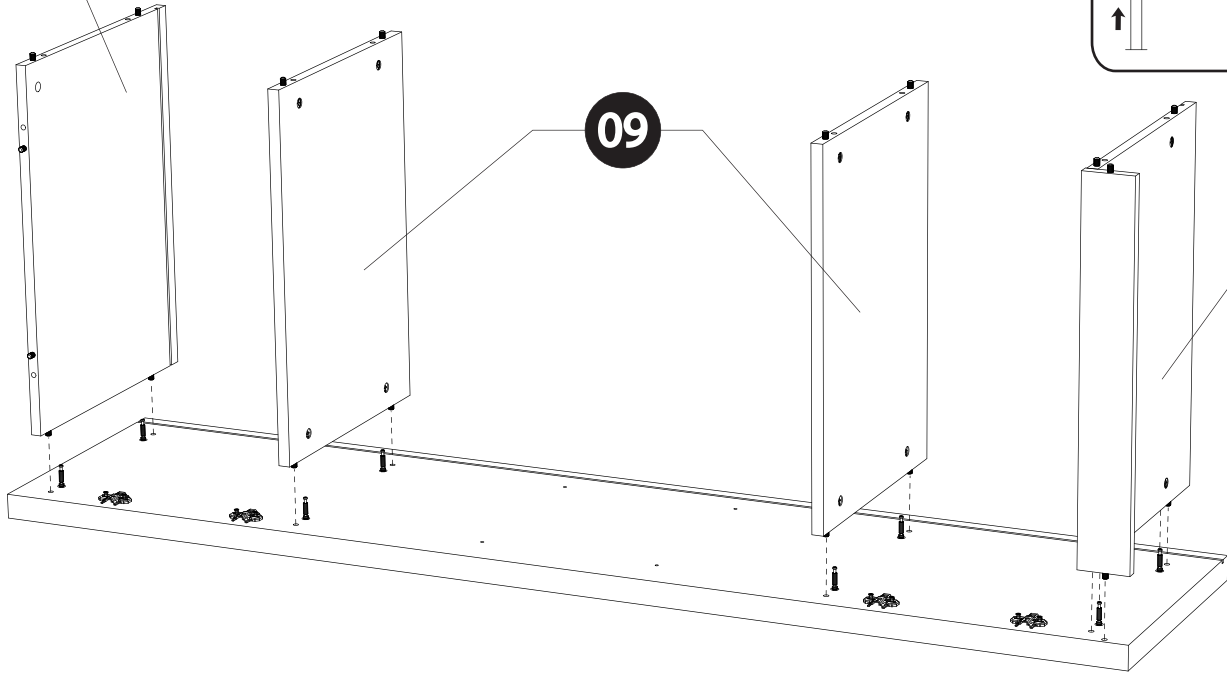

09

01

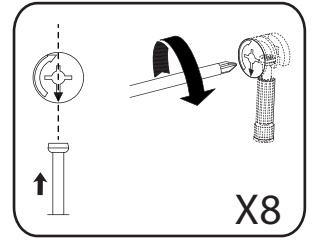

X8

# 6

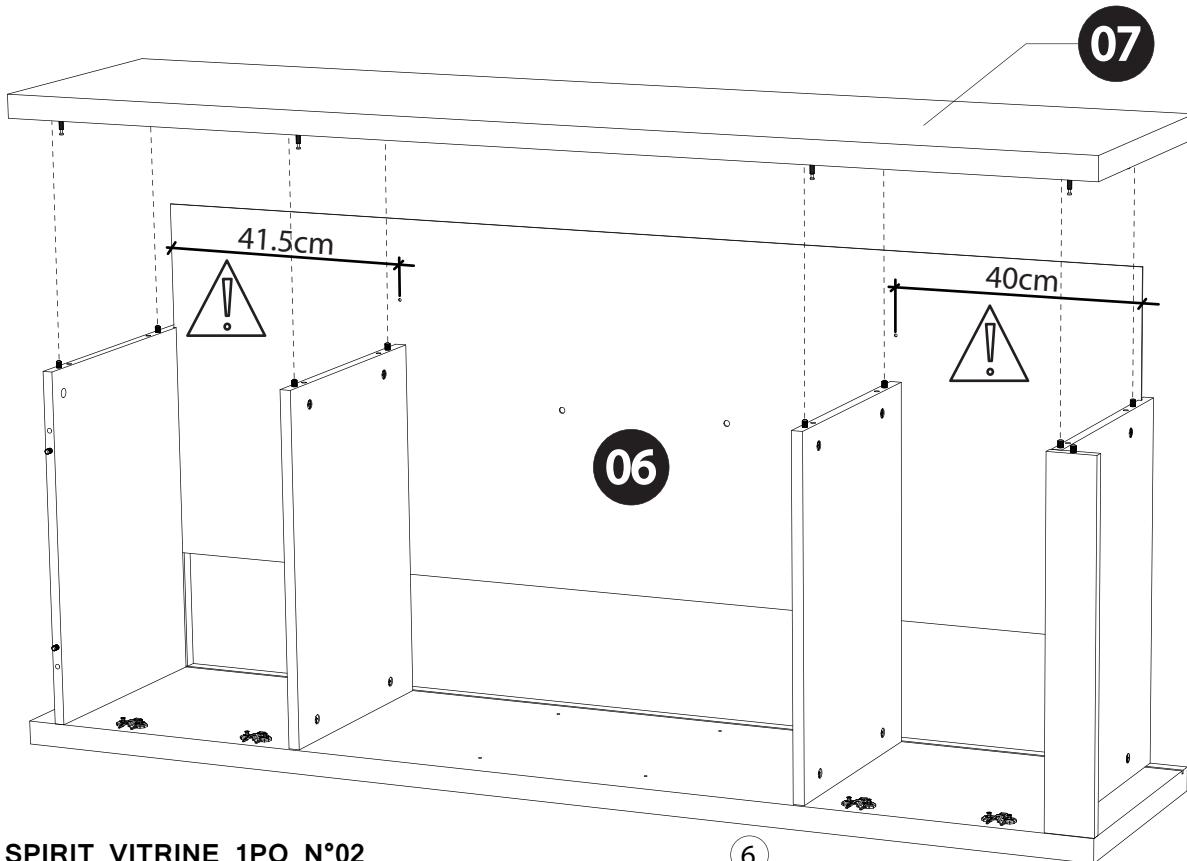
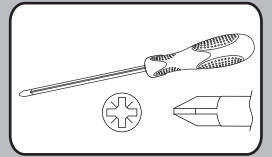

07

06

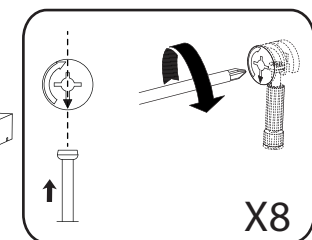

X8

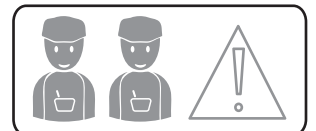

7

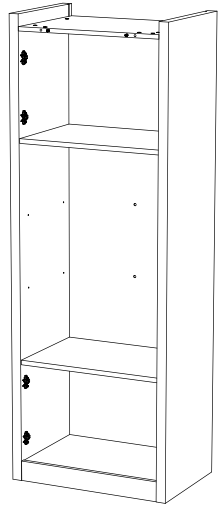
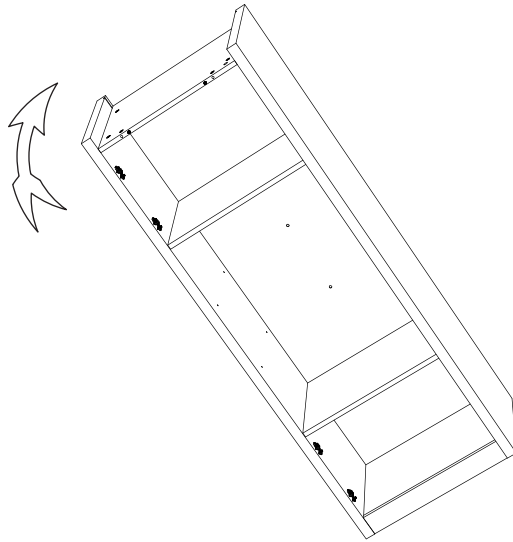
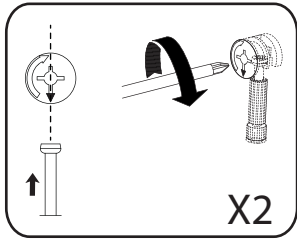
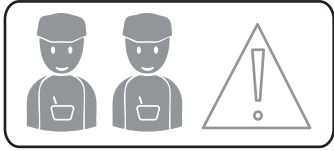
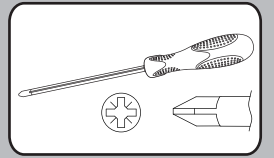
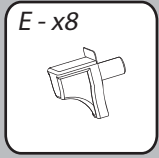

18

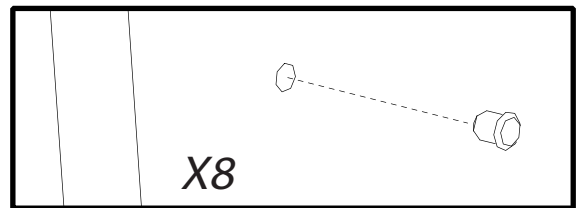
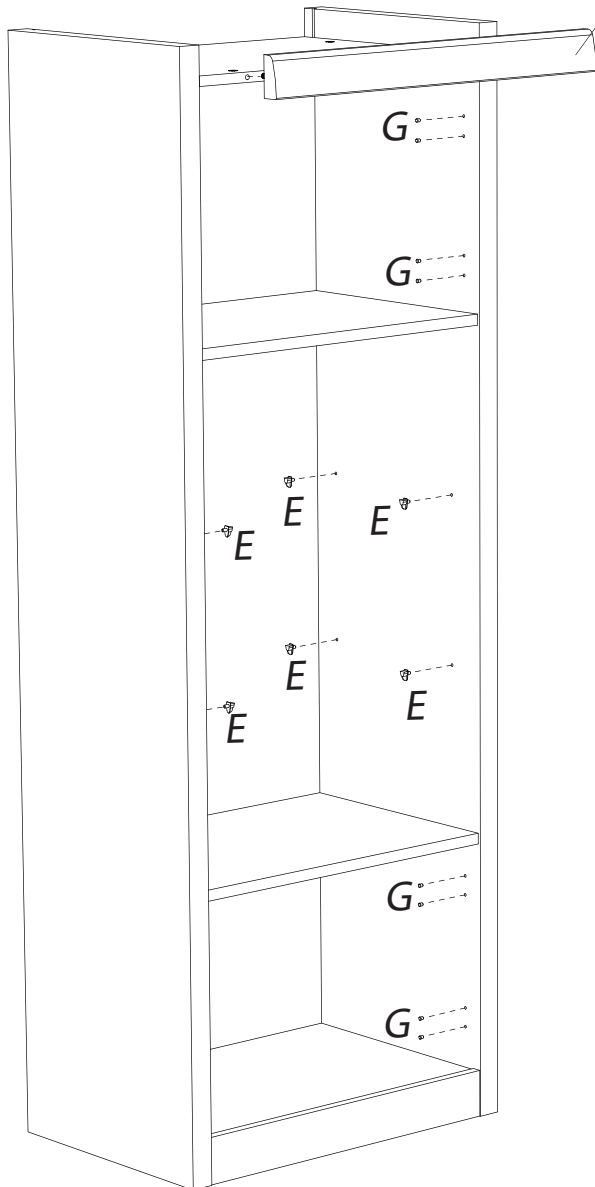



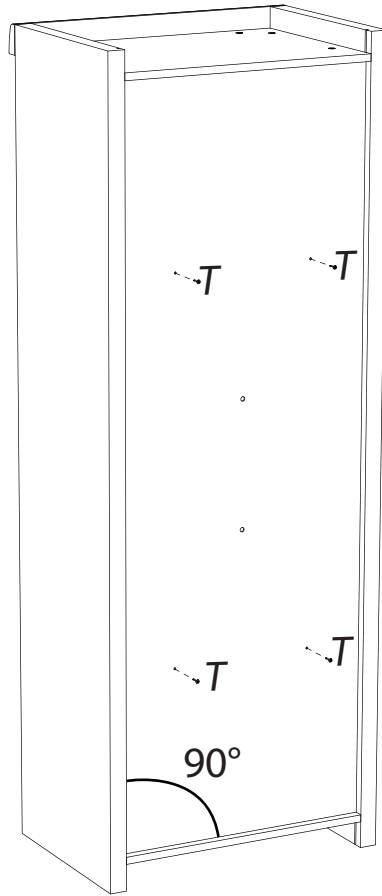
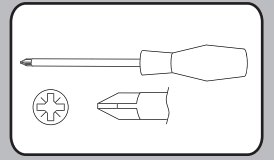
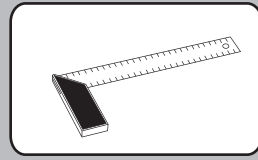
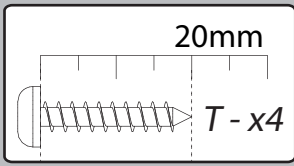



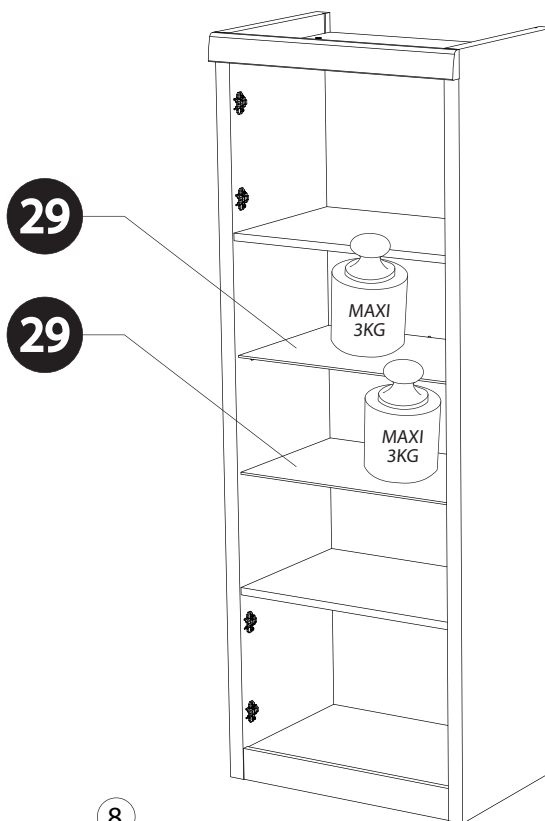
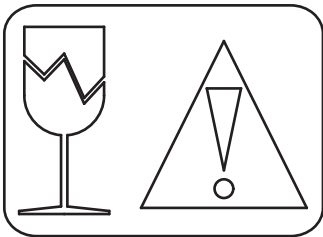



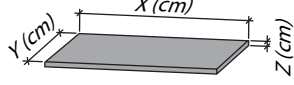
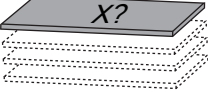
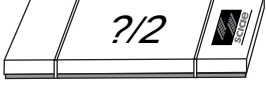

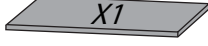
8

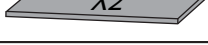

9

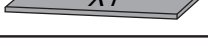
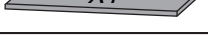



<i>DESIGNATION</i>		N°		
Dessous	57.4 x 41 x 1.6	1		1
Côté gauche	180 x 42.8 x 3.8	2		2
Derrière	167 x 58.4 x 0,25	6		2
Côté droit	180 x 42.8 x 3.8	7		2
Dessus	57.4 x 42.8 x 1.6	8		1
Tablette fixe	57.4 x 39.8 x 1.8	9		1
Pnx haut de porte	57.4 x 42.1 x 2.2	10		1
Pnx bas de porte	57.4 x 42.1 x 2.2	11		1
Face de socle	57.4 x 7.8 x 1.6	17		1
Bandeau	65.2 x 6.5 x 2.8	18		1
Tablette verre	57.2 x 39 x 0.5	29		1
Glace de porte	94 x 56.8 x 0.5	34		1

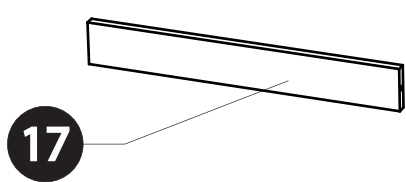
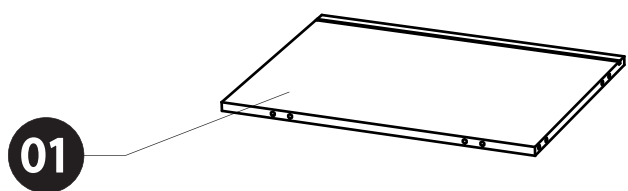
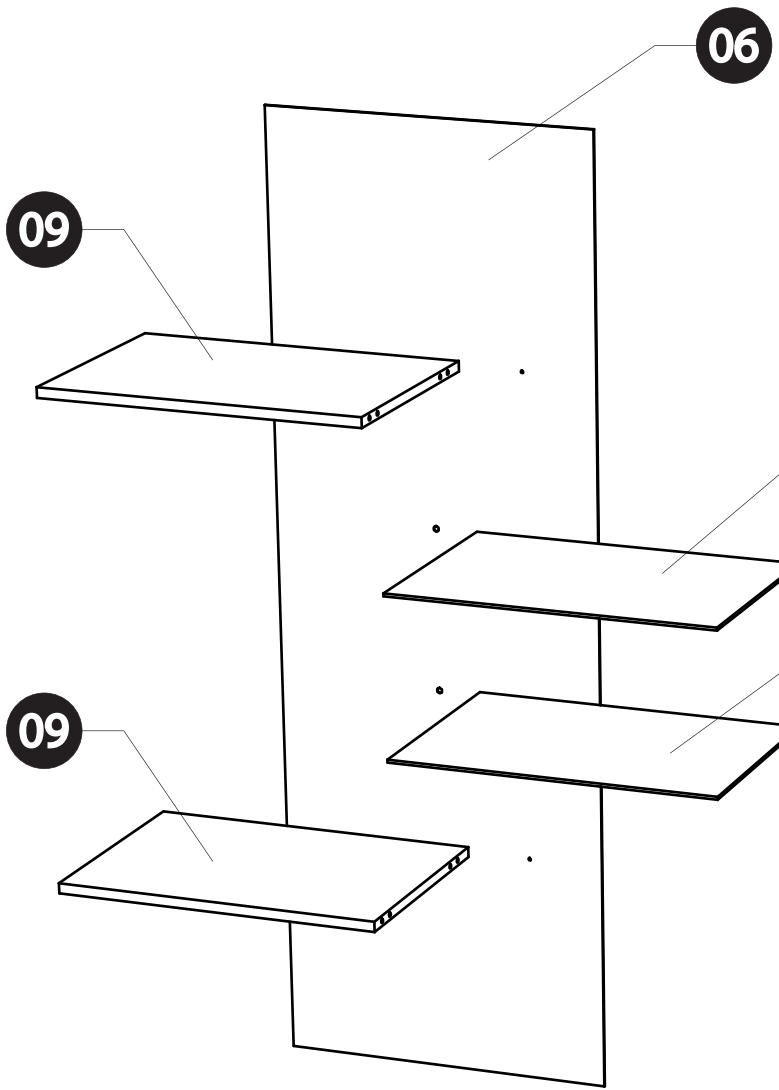
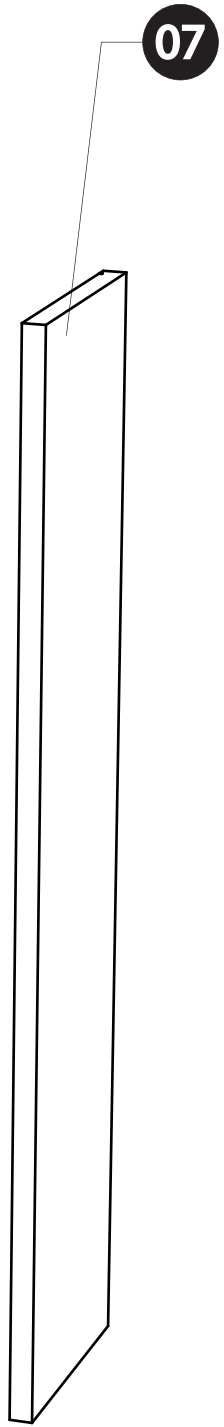
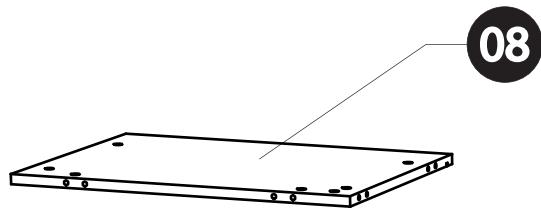
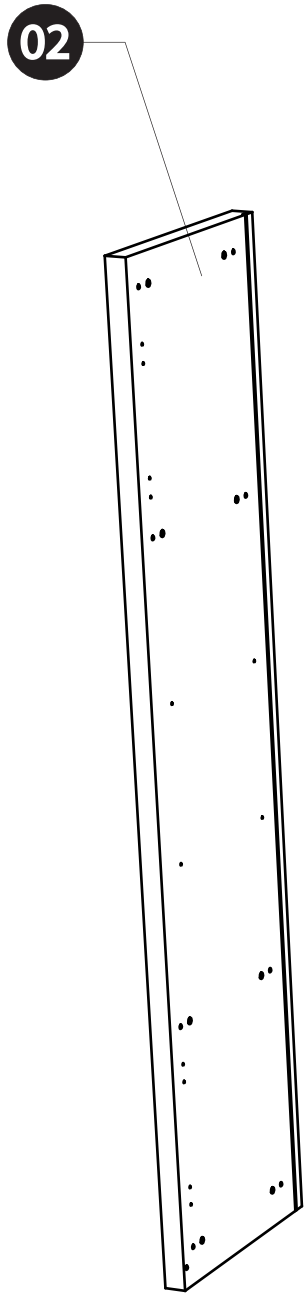

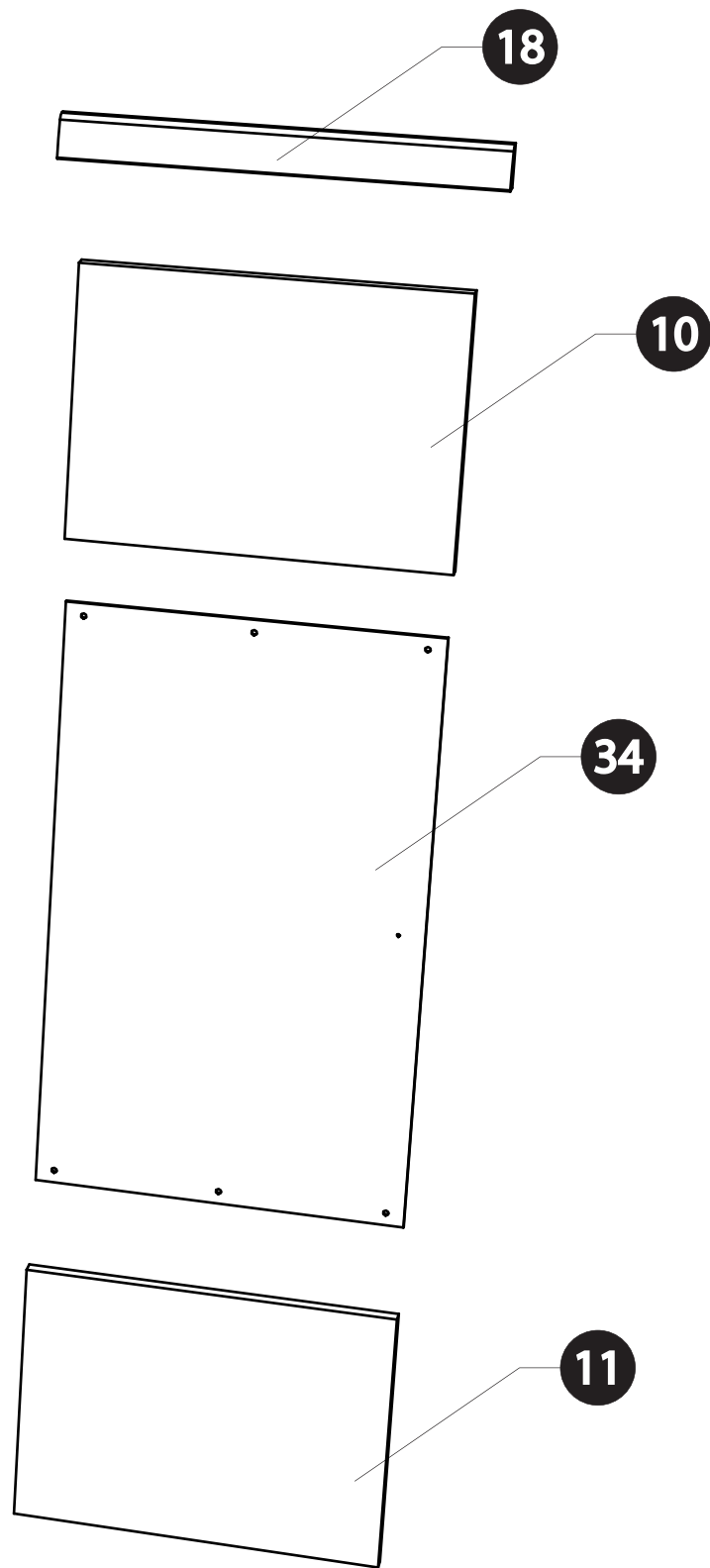

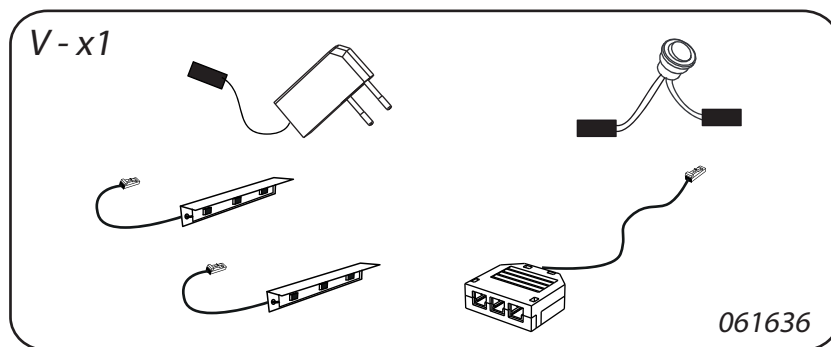
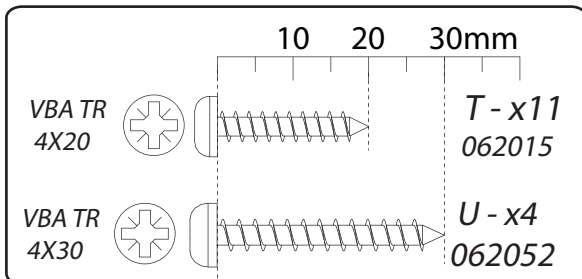
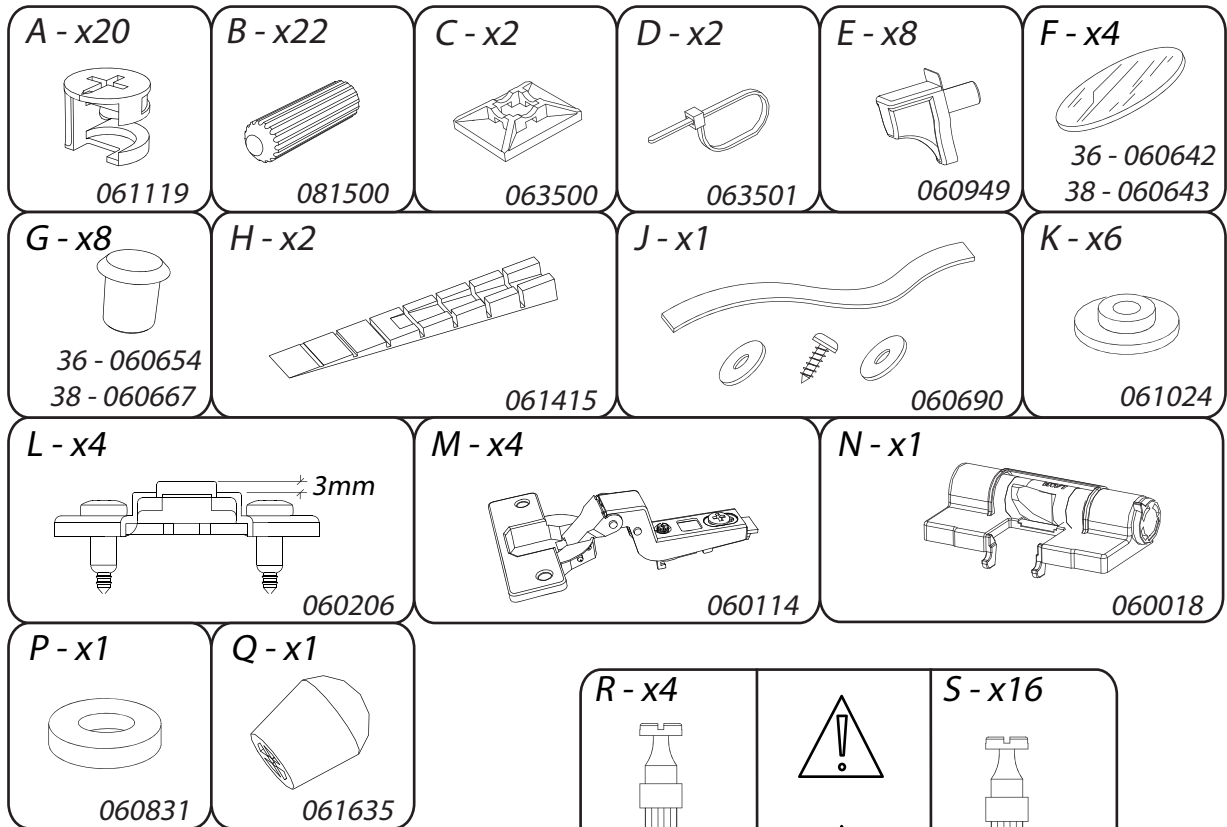

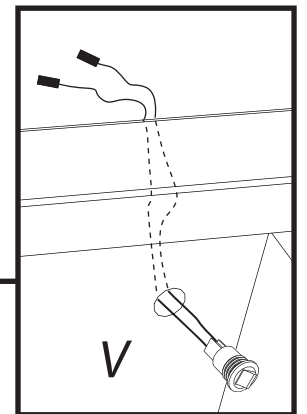
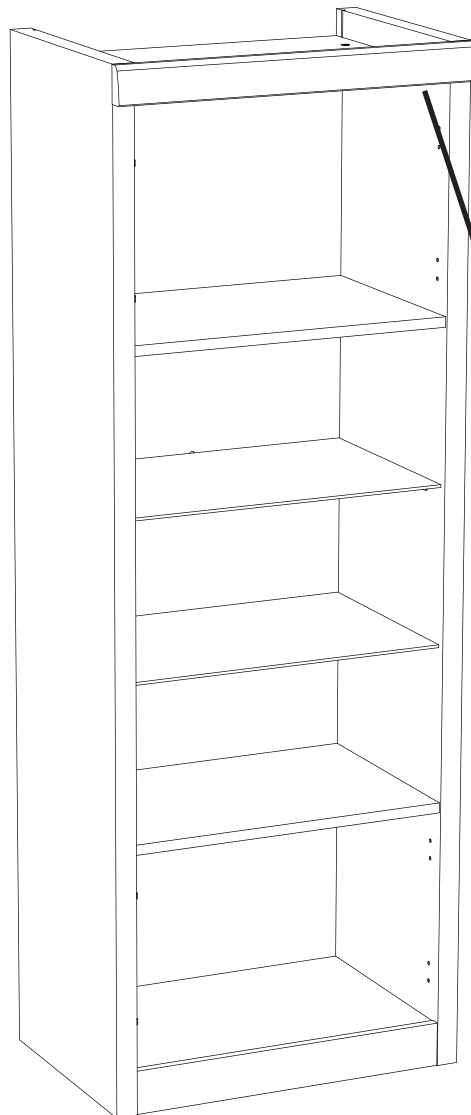
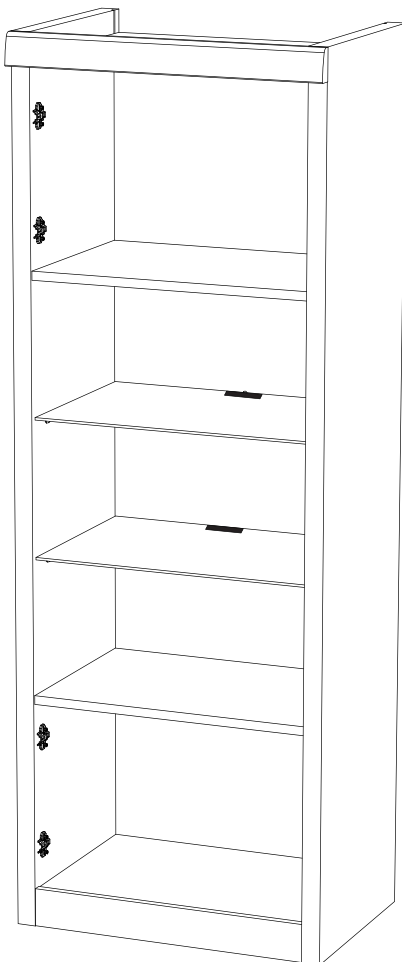
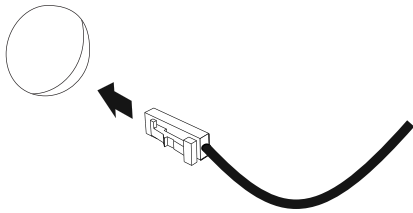
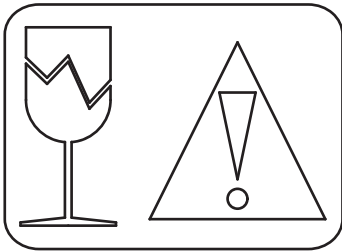
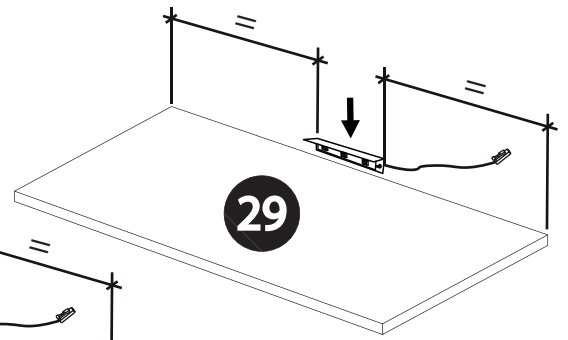
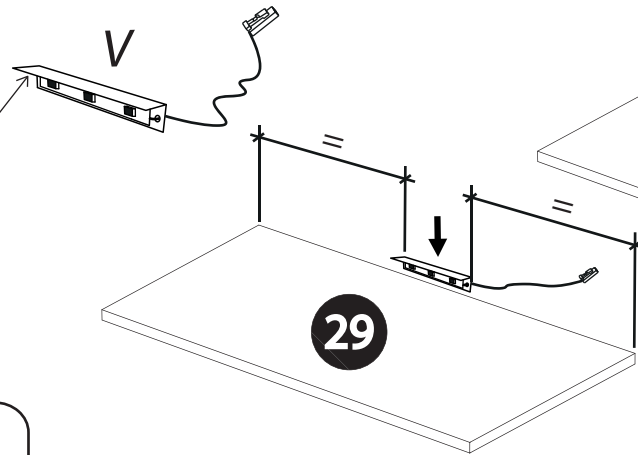
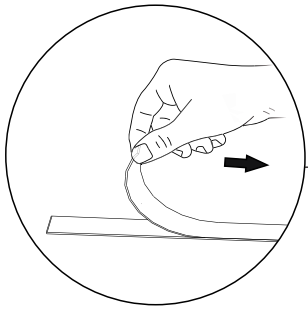
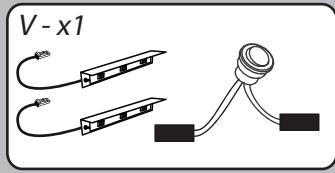

V-x1

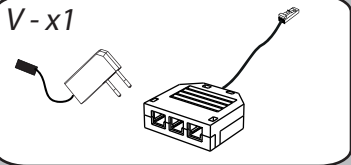

C-x2

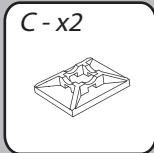

D-x2

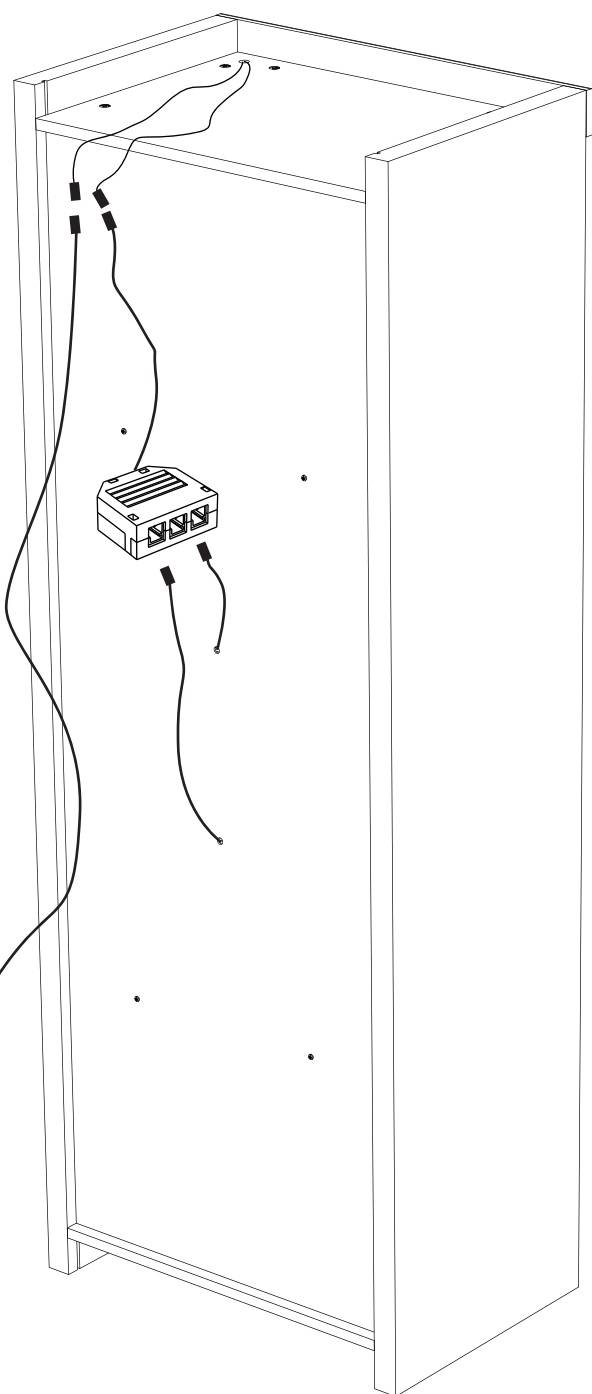
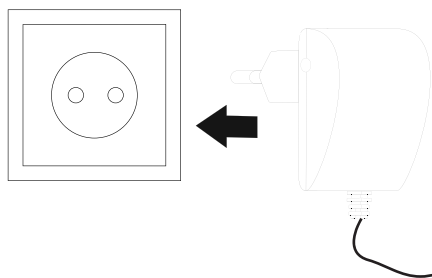
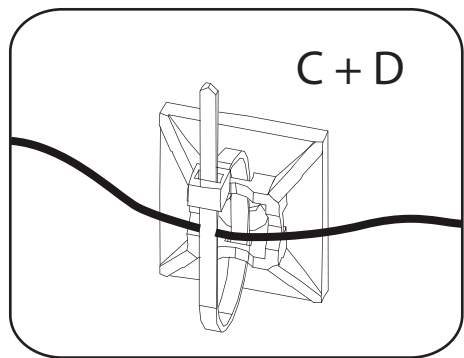
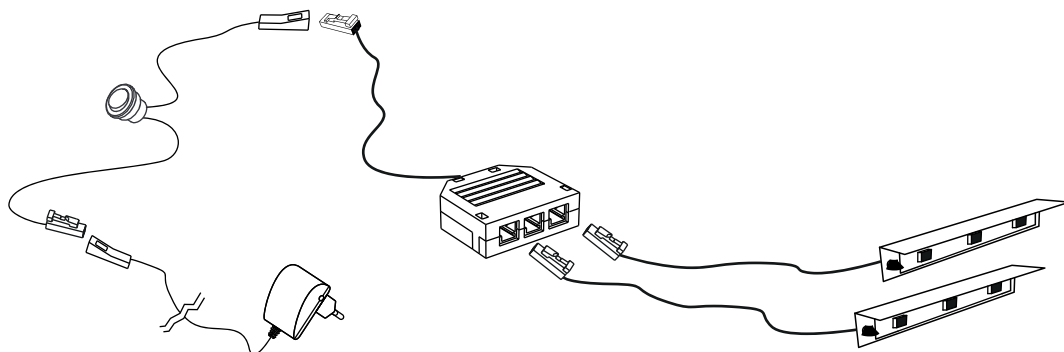
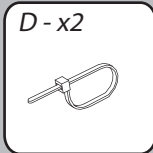

J - x1

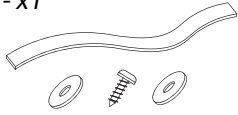

H - x2

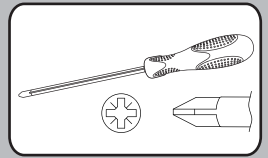
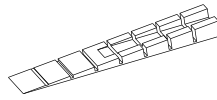

FRANCAIS: Pour votre sécurité il est impératif de fixer votre meuble au mur.  
 ENGLISH: For your own safety, this furniture must be fastened to the wall imperatively.  
 DEUTSCH: Zu Ihre Sicherheit, ist es notwendig Ihr Möbel auf dem Wand zu fixieren.

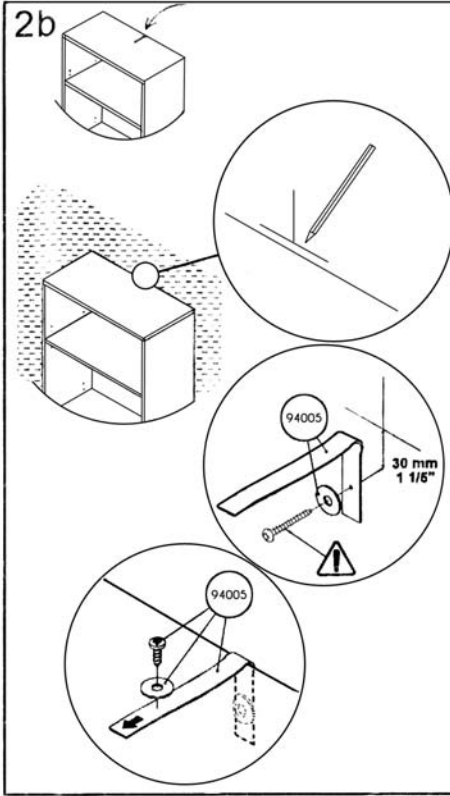
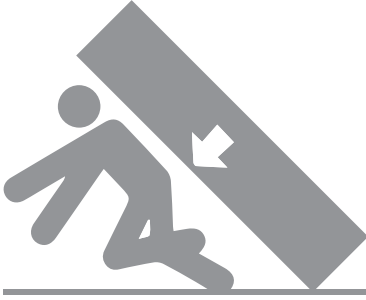

0194007-50

FRANCAIS  
**IMPORTANT:** La vis fournie avec le dispositif anti-bascule est destinée à fixer le dispositif dans le meuble. Pour la fixation au mur, compléter par une vis adaptée au support mural. En cas de doute, contacter un magasin de bricolage.

ENGLISH  
**IMPORTANT:** The screw supplied together with the anti-topple bracket is to be used only for fixing the anti-topple bracket to the furniture. In addition to this, you will need to choose a screw or fitting which is suitable for securing the bracket to the kind of walls you have. If you are unsure about what type of screw to use contact your local hardware store.

DEUTSCH  
**WICHTIG:** Die dem kippschutz beigefügten schrauben sind ausschließlich für die befestigung des kippschutzes am möbelstück vorgesehen. Für die befestigung des kippschutzes an der wand benötigen sie zusätzlich schrauben oder beschläge, die zur beschaffenheit der wand passen. Falls sie nicht sicher sind, welche art von schrauben geeignet sind, wenden sie sich bitte an den fachhandel.

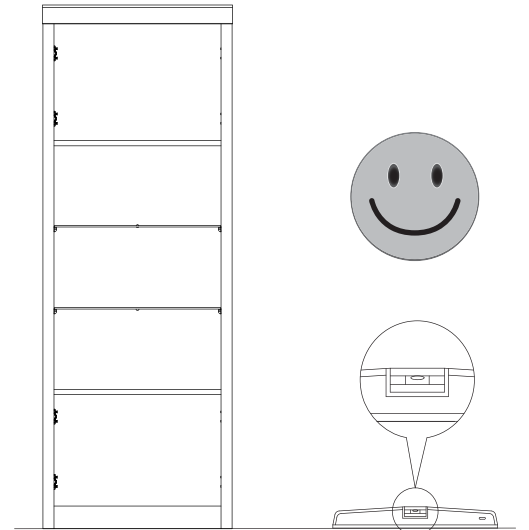
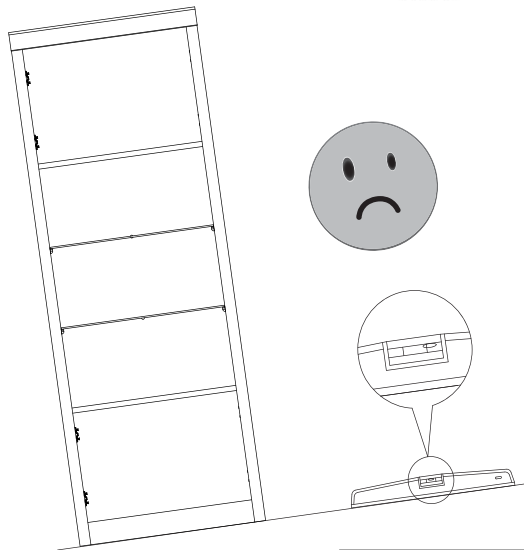
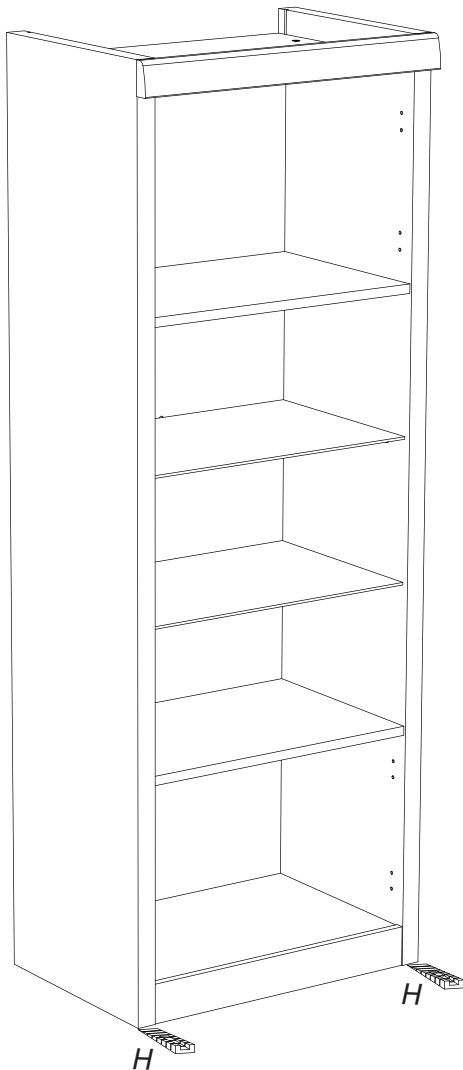

# 13

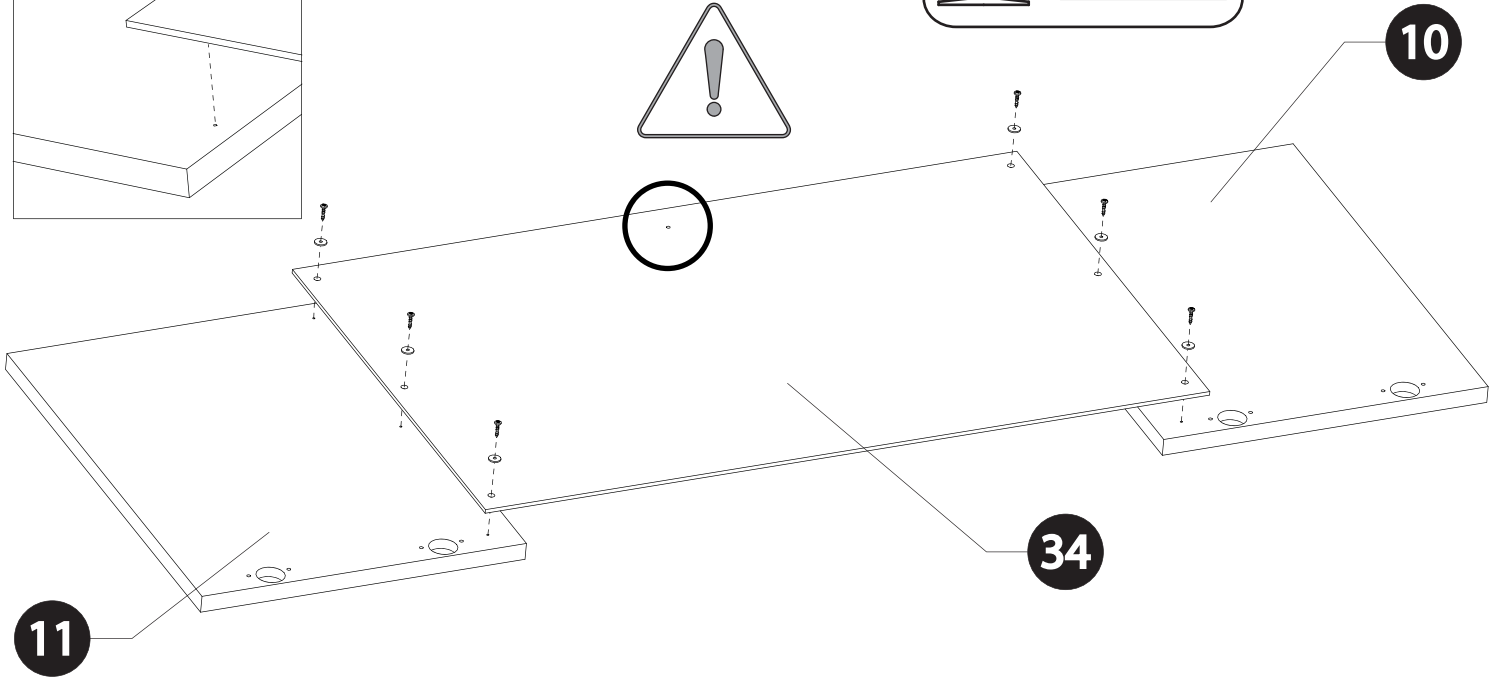
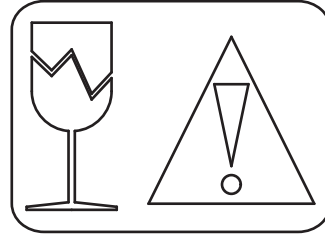
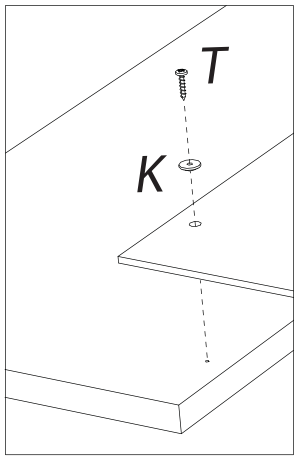
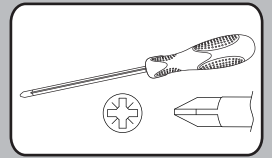
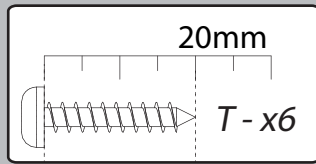
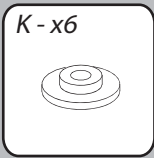

# 14

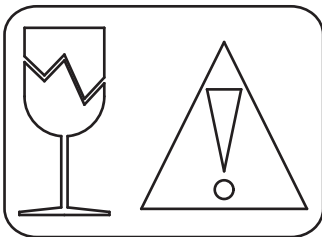
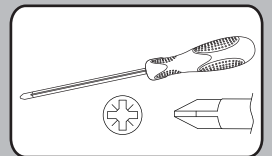
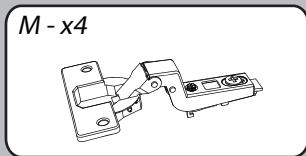



N - x1

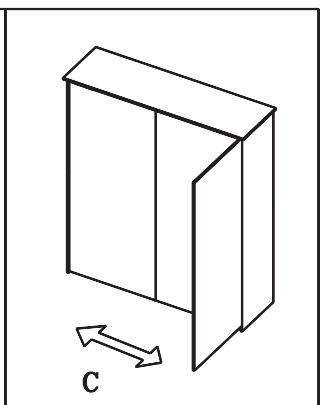
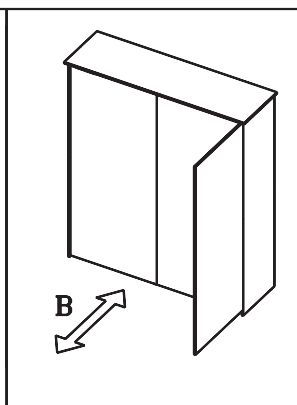
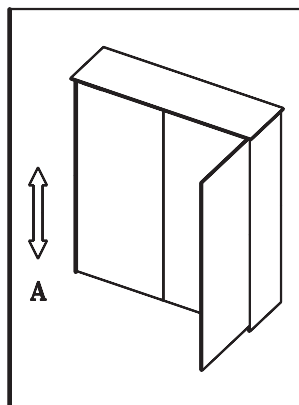
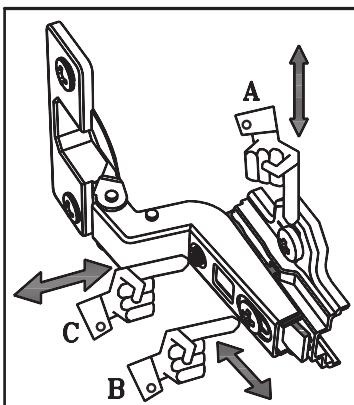
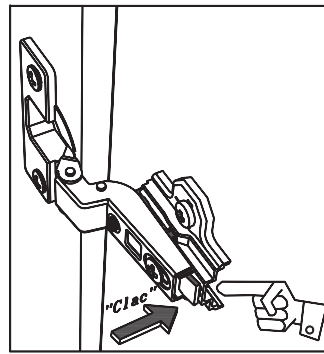
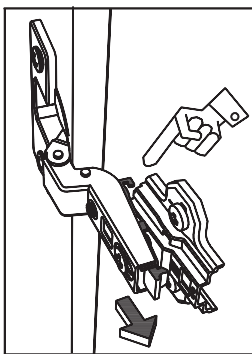
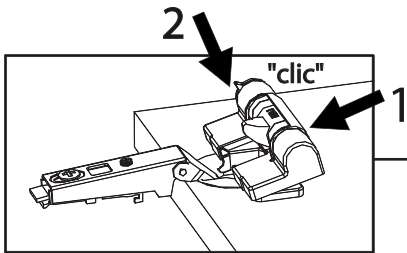
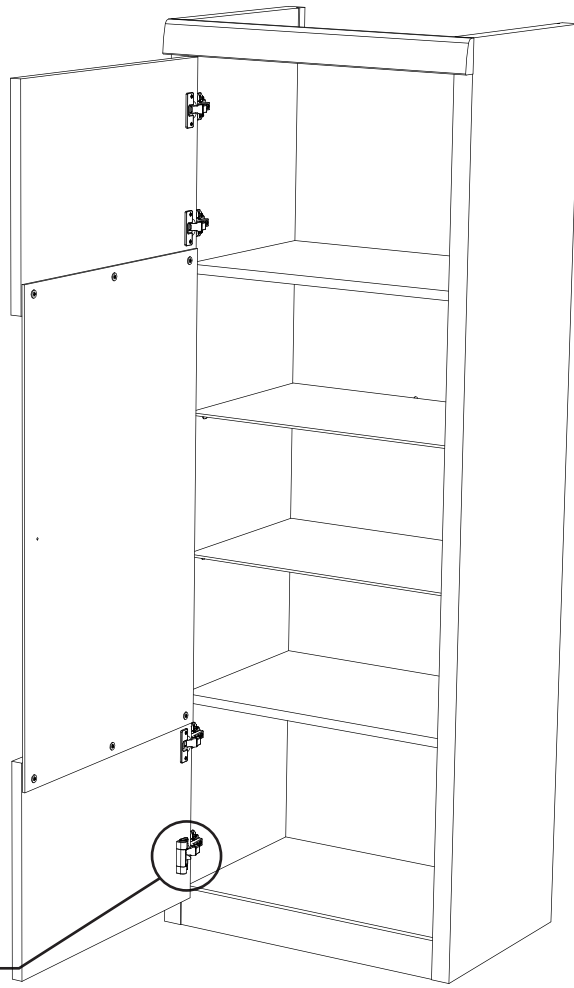
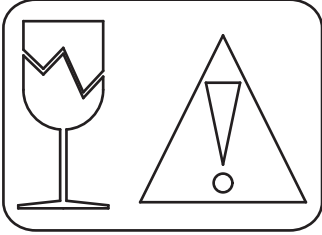
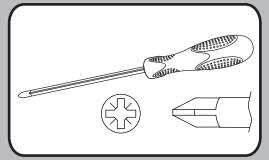
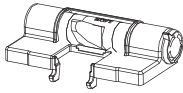

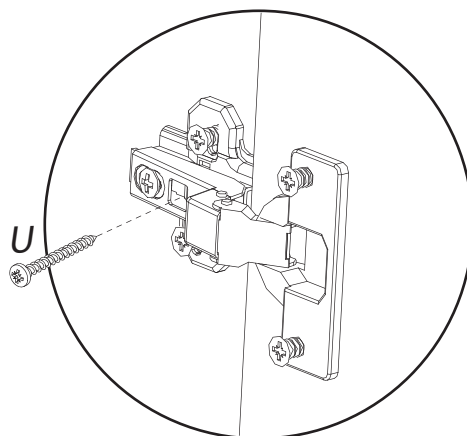
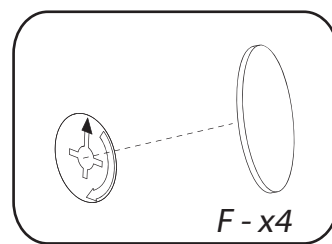
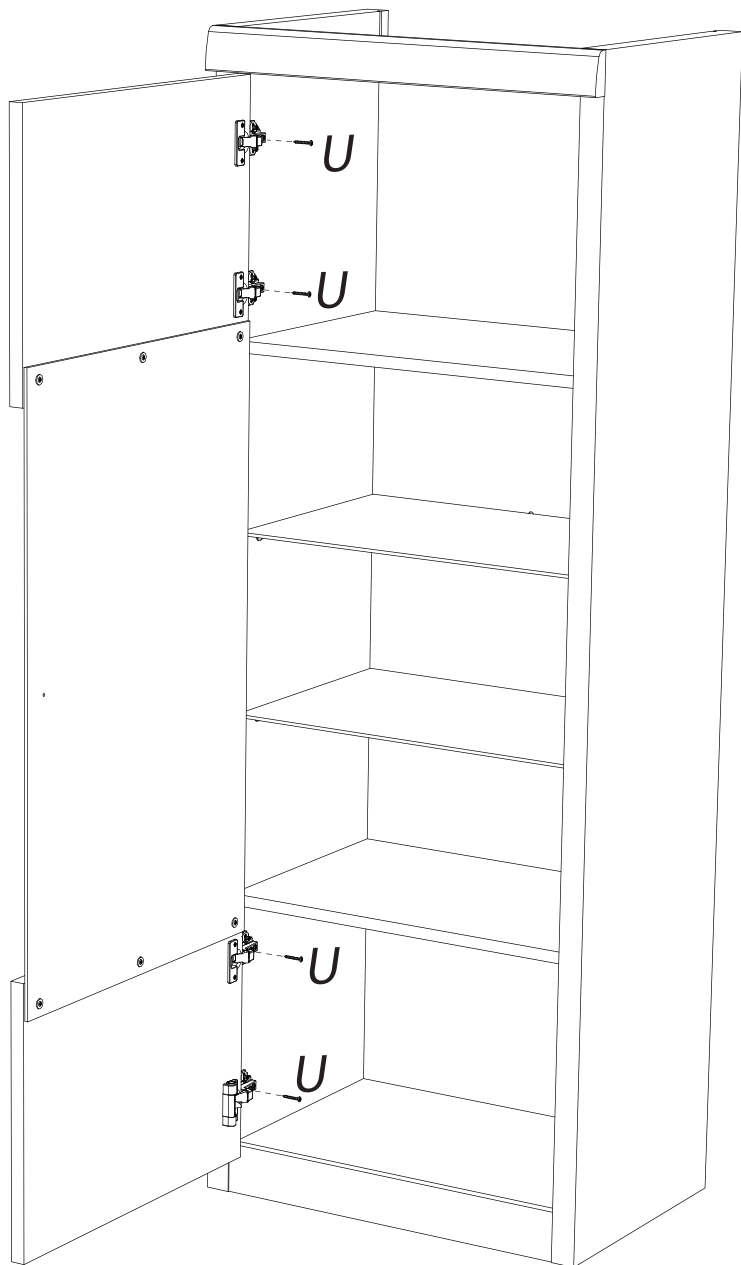
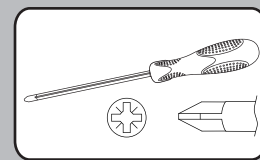
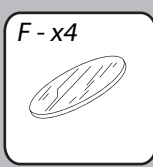
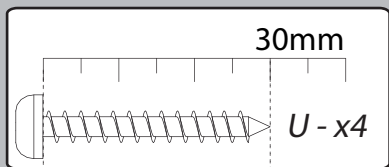

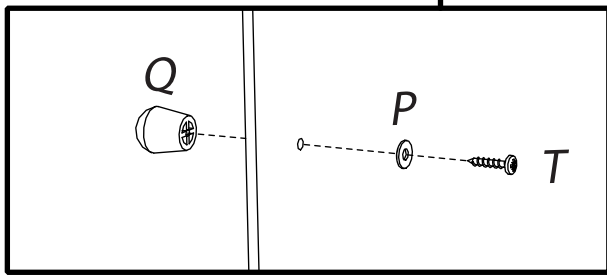
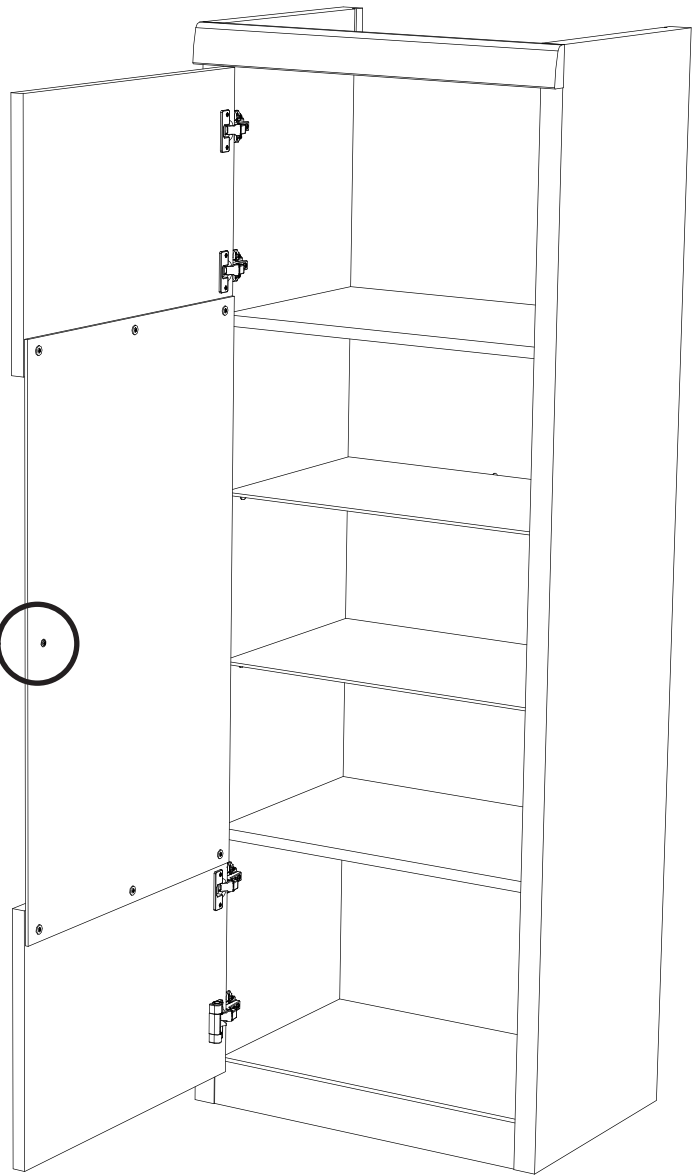
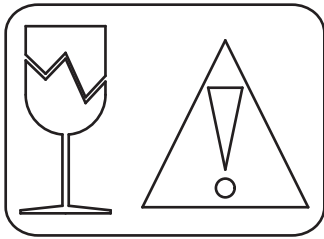
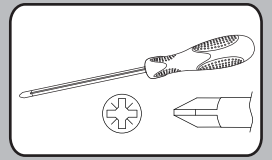
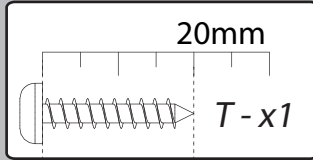
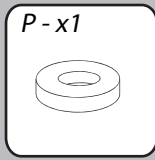
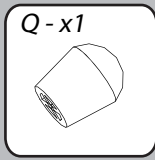

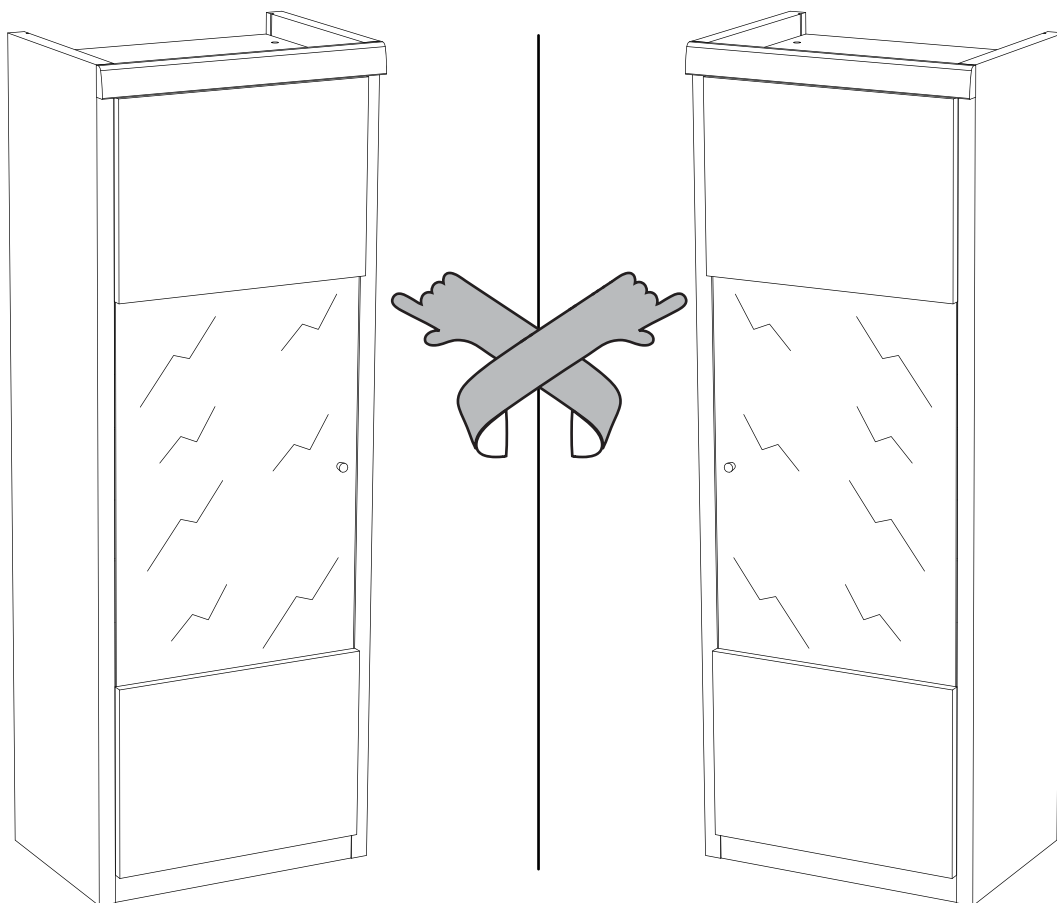

#### SPIRIT 36:

Vitrine 1po composé de panneaux de particules revêtus papier blanc laqués blanc brillant.  
L.65 cm - H.180 cm - P.45 cm.

A monter soi-même.

#### SPIRIT 38:

Vitrine 1po composé de panneaux de particules revêtus papier noir laqués noir brillant.  
L.65 cm - H.180 cm - P.45 cm.

A monter soi-même.

FRANCAIS

#### Recommandations de démontage :

En cas de déménagement, il convient de procéder au démontage de votre meuble, en ôtant toute la visserie.

ENGLISH

#### Disassembly advices:

In case of moving, it is needed to dismantle the furniture removing the fittings.

DEUTSCH

#### Empfehlungen für die Demontage:

Bei Transport bitte alle Beschläge demontieren.

"Les meubles contenant des panneaux à base de bois (panneaux de particules, panneaux de fibres, contreplaqué...) peuvent émettre des substances polluantes dans l'air intérieur. Il est ainsi recommandé, après l'installation du meuble dans son logement, d'aérer fréquemment la pièce concernée pendant au moins quatre semaines afin de réduire son exposition aux polluants émis par le meuble."